

- Up To 10W Per Channel
- 1 or 2 Channels in a One Slot Module
- Resistance Resolution to 0.125Ω
- Values From 1Ω to 102kΩ
- Short and Open Simulation
- Simple Software Control Through Resistance Calls
- VISA & Kernel Drivers Supplied for Windows
- Supported by PXI or LXI Chassis
- 3 Year Warranty



Part of a growing range of medium to high power resistor modules, the 40-253 provides a simple solution for applications requiring up to 10W of power handling capability. The 40-253 is available in a variety of resistance ranges and resolutions that meet the needs of most functional test systems.

Each channel of the 40-253 is able to simulate short circuit and open circuit conditions that can be experienced in a system caused by faulty wiring or sensors.

Software control is simplified by the use of resistor value calls. The module works out the resistance setting closest to the requested value and sets that value. The user can interrogate the module to find the actual setting used.

A calibration cable assembly can be attached to the module in place of the UUT to enable a DMM to be used for verifying the resistor channels. This considerably simplifies the checking of the module's calibration.

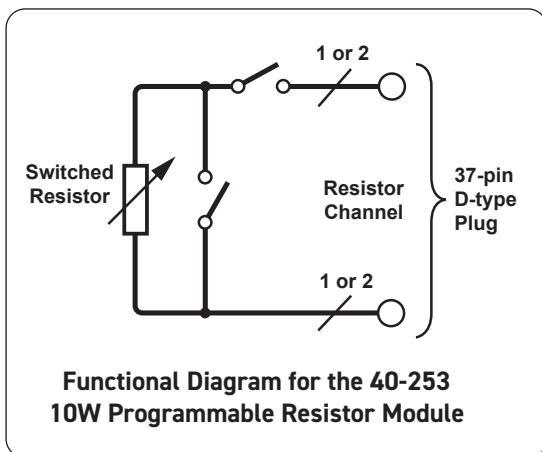

Pickering's Range of PXI Resistor Modules			
Model No.	Description	Channels	Range
40-251	2.5W Programmable Resistor	1, 2, 4 or 8	Up to 22MΩ
40-252	5W Programmable Resistor	1, 2, or 4	Up to 22MΩ
40-253	10W Programmable Resistor	1 or 2	Up to 102kΩ
40-280/1/2	Selectable	12 to 48	User Specified
40-290	Programmable Resistor	2	0.5Ω to 32kΩ
40-291		4	0.5Ω to 128Ω
40-292	Programmable Load	1	40Ω to 295Ω or 10Ω to 2.56kΩ
40-293	Programmable Resistor + SPDT	2 or 4	Up to 131kΩ
40-294	Programmable Resistor + SPST	2 or 4	Up to 131kΩ
40-295	Programmable Resistor	3, 6, 5, 10 or 18	Up to 16MΩ
40-296	Programmable Potentiometer	1, 2, 3, 4, 5 or 9	Up to 16MΩ
40-297	High Density Precision Resistor	3, 4, 6,	Up to 22.3MΩ
40-298		9 or 18	
Precision Resistor Modules			
For applications requiring a Resistor Module with greater resolution (to <2mΩ) or better accuracy (to <0.03%), look to our Precision Resistor range which includes models 40-260, 40-261, 40-262, 40-265, and 40-297			
Custom Resistor Modules			
If our range of Resistor Modules does not meet your specific requirements, please contact you local sales office to discuss your application. Customizations include: different start and stop values, current, power, voltage, precision, accuracy, number of channels, connector etc.			

The 40-253 is available in 20 standard builds that suit the most common configurations:

- Narrow resistance range version, available in 1 or 2 channel variants.
- Medium resistance range version, available in 1 channel variants.
- Wide resistance range version, available in 1 channel variants.

For applications requiring greater density with lower power, users should consider the 40-297 High Density Precision Resistor Modules.

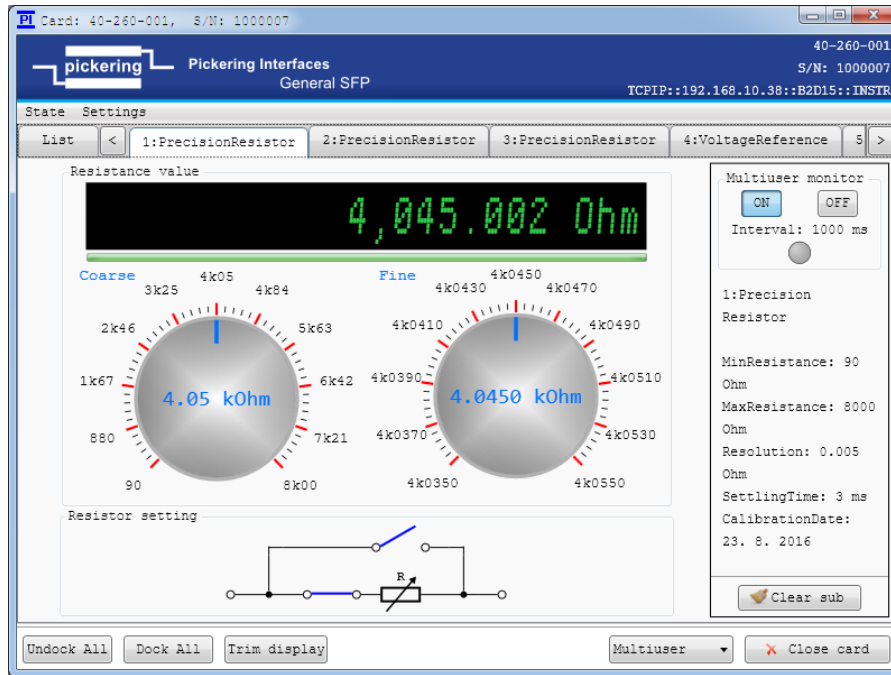

Soft Front Panel for the Programmable Resistor Module

PXI Part Number (Number of Channels)	Resistance Range									Resolution
	1Ω	10Ω	100Ω	1kΩ	10kΩ	100kΩ	1MΩ	10MΩ	100MΩ	
40-253-010 (2) 40-253-110 (1)	[Red bar from 1Ω to ~10Ω]									0.125Ω
40-253-011 (2) 40-253-111 (1)	[Red bar from 1Ω to ~20Ω]									0.25Ω
40-253-012 (2) 40-253-112 (1)	[Red bar from 1Ω to ~50Ω]									0.5Ω
40-253-013 (2) 40-253-113 (1)	[Red bar from 1Ω to ~100Ω]									1Ω
40-253-014 (2) 40-253-114 (1)	[Red bar from 1Ω to ~200Ω]									2Ω
40-253-020 (1)	[Red bar from 1Ω to ~500Ω]									0.125Ω
40-253-021 (1)	[Red bar from 1Ω to ~1kΩ]									0.25Ω
40-253-022 (1)	[Red bar from 1Ω to ~2kΩ]									0.5Ω
40-253-023 (1)	[Red bar from 1Ω to ~5kΩ]									1Ω
40-253-024 (1)	[Red bar from 1Ω to ~10kΩ]									2Ω
40-253-030 (1)	[Red bar from 1Ω to ~20kΩ]									0.125Ω
40-253-031 (1)	[Red bar from 1Ω to ~50kΩ]									0.25Ω
40-253-032 (1)	[Red bar from 1Ω to ~100kΩ]									0.5Ω
40-253-033 (1)	[Red bar from 1Ω to ~200kΩ]									1Ω
40-253-034 (1)	[Red bar from 1Ω to ~500kΩ]									2Ω

Graphical Representation of the 40-253 Programmable Resistor Module Range

## Specifications

Accuracy (low power):	$\pm 0.3\% \pm \text{Resolution @ } \pm 10^\circ\text{C}$ from calibration temperature (factory calibration @ $21^\circ\text{C}$ )
Fault Simulation:	Open and short circuit (typically $< 0.3\Omega$ )
Power:	10W maximum per channel†
Maximum Current:	1A or as limited by power
Maximum Voltage:	100V* or as limited by power
Settling time:	$< 3\text{ms}\ddagger$
Number of Operations:	$1 \times 10^8$ (low power), $1 \times 10^6$ (high power)
Software Control:	By resistance calls to module for selected channel.
Calibration:	4-wire resistance measurement of selected channel for verification purposes with UUT removed and a special cable assembly attached. Factory calibration data is stored in the module.

\* For full voltage rating, signal sources must be fully isolated from mains supply and safety earth.

† Or as limited by voltage/current, refer to power plot for guidance.

‡ The total operate time when setting a resistance may be longer depending upon the change requested due to relay sequencing.

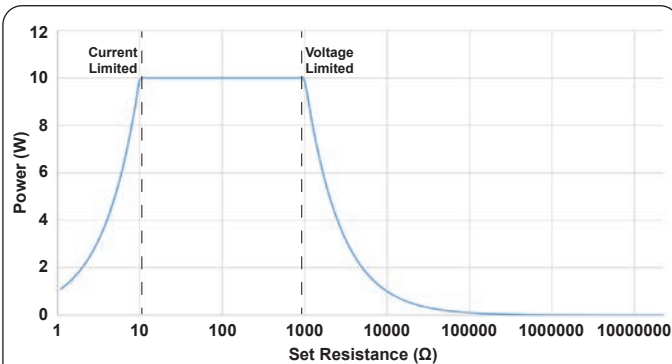

**40-253 Maximum Power for a Given Resistance Setting**

## Power Requirements

+3.3V	+5V	+12V	-12V
0.3A	0.3A	0	0

## Mechanical Characteristics

1 slot 3U PXI (CompactPCI card).

3D models for all versions in a variety of popular file formats are available on request.

## Connectors

PXI bus via 32-bit P1/J1 backplane connector.

Resistor channels via front panel 37-pin male D-Type connector.

For pin outs please refer to the operating manual.

## Operating/Storage Conditions

### Operating Conditions

Operating Temperature:	$0^\circ\text{C}$ to $+55^\circ\text{C}$
Humidity:	Up to 90% non-condensing
Altitude:	5000m

### Storage and Transport Conditions

Storage Temperature:	$-20^\circ\text{C}$ to $+75^\circ\text{C}$
Humidity:	Up to 90% non-condensing
Altitude:	15000m

## PXI & CompactPCI Compliance

The module is compliant with the PXI Specification 2.2. Local Bus, Trigger Bus and Star Trigger are not implemented.

Uses a 33MHz 32-bit backplane interface.

## Safety & CE Compliance

All modules are fully CE compliant and meet applicable EU directives: Low-voltage safety EN61010-1:2010, EMC Immunity EN61326-1:2013, Emissions EN55011:2009+A1:2010.

## Resistor Module Order Codes

### 0.125Ω Resolution

Range	No. of Channels	Order Code	No. of Channels	Order Code
1Ω to 31.5Ω	1	<b>40-253-110</b>	2	<b>40-253-010</b>
1.5Ω to 472Ω			1	<b>40-253-020</b>
2Ω to 6.97kΩ			1	<b>40-253-030</b>

### 0.25Ω Resolution

Range	No. of Channels	Order Code	No. of Channels	Order Code
1Ω to 62.1Ω	1	<b>40-253-111</b>	2	<b>40-253-011</b>
1.5Ω to 925Ω			1	<b>40-253-021</b>
2Ω to 13.6kΩ			1	<b>40-253-031</b>

### 0.5Ω Resolution

Range	No. of Channels	Order Code	No. of Channels	Order Code
1Ω to 122Ω	1	<b>40-253-112</b>	2	<b>40-253-012</b>
1.5Ω to 1.81kΩ			1	<b>40-253-022</b>
2Ω to 26.7kΩ			1	<b>40-253-032</b>

### 1Ω Resolution

Range	No. of Channels	Order Code	No. of Channels	Order Code
1Ω to 239Ω	1	<b>40-253-113</b>	2	<b>40-253-013</b>
1.5Ω to 3.55kΩ			1	<b>40-253-023</b>
2Ω to 52.4kΩ			1	<b>40-253-033</b>

### 2Ω Resolution

Range	No. of Channels	Order Code	No. of Channels	Order Code
1Ω to 470Ω	1	<b>40-253-114</b>	2	<b>40-253-014</b>
1.5Ω to 6.97kΩ			1	<b>40-253-024</b>
2Ω to 102kΩ			1	<b>40-253-034</b>

## Other Resistor Modules

Pickering Interfaces manufacture a range of variable resistor modules in the PXI format. If you have a requirement for a variable resistor module please contact your local sales office with the information below and we will advise you on the best solution for your application.

Lowest Resistance †	<input type="text"/>
Highest Resistance	<input type="text"/>
Resistance Resolution	<input type="text"/>
Overall Accuracy	<input type="text"/>
Maximum Power/Current	<input type="text"/>
Number of Channels (variable resistors)	<input type="text"/>

† Resistance is as measured across the user connector terminals, minimum resistance must have a non-zero value.

## Product Customization

Pickering PXI modules are designed and manufactured on our own flexible manufacturing lines, giving complete product control and enabling simple customization to meet very specific requirements.

Customization can include:

- Alternative resistance range
- Alternative resolution
- Different number of channels
- Different performance specifications

All customized products are given a unique part number, fully documented and may be ordered at any time in the future. Please contact your local sales office to discuss.

## Accessories

Calibration lead for 4-wire DMM resistance measurement - 37-pin D-type socket to shrouded 4mm bayonet plugs, 1m length **40-975-037-1m**

## Mating Connectors & Cabling

For connection accessories for the 40-253 please refer to the [90-007D](#) 37-pin D-Type Connector Accessories data sheet where a complete list and documentation can be found for accessories, or refer to the Connection Solutions catalog.

## Chassis Compatibility

This PXI module must be used in a suitable chassis. It is compatible with the following chassis types:

- All chassis conforming to the 3U PXI and 3U Compact PCI (cPCI) specification
- Legacy and Hybrid Peripheral slots in a 3U PXI Express (PXIe) chassis
- Pickering Interfaces LXI or LXI/USB Modular Chassis

## Chassis Selection Guide

### Standard PXI or hybrid PXIe Chassis from any Vendor:

- Mix our 1000+ PXI switching & simulation modules with any vendor's PXI instrumentation
- Embedded or remote Windows PC control
- Real-time Operating System Support
- High data bandwidths, especially with PXI Express
- Integrated module timing and synchronization

### Pickering LXI or LXI/USB Modular Chassis—only accept our 1000+ PXI Switching & Simulation Modules:

- Ethernet or USB control enables remote operation
- Low-cost control from practically any controller
- LXI provides manual control via Web browsers
- Driverless software support
- Power sequencing immunity
- Ethernet provides chassis/controller voltage isolation
- Independence from Windows operating system



## Connectivity Solutions

We provide a full range of supporting cable and connector solutions for all our switching products—20 connector families with 1200+ products. We offer everything from simple mating connectors to complex cables assemblies and terminal blocks. All assemblies are manufactured by Pickering and are guaranteed to mechanically and electrically mate to our modules.

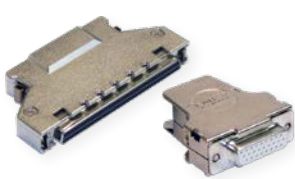

Connectors & Backshells



Multiwire Cable Assemblies

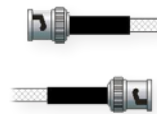

RF Cable Assemblies



Connector Blocks

We also offer customized cabling and have a free online **Cable Design Tool** that can be used to create custom cable solutions for many applications.

Visit: [pickeringtest.com/cdt](http://pickeringtest.com/cdt) to start your design.

### Mass Interconnect

We recommend the use of a mass interconnect solution when an Interchangeable Test Adapter (ITA) is required for a PXI or LXI based test system. Our modules are fully supported by both Virginia Panel and MacPanel.

### Pickering Reed Relays

We are the only switch provider with in-house reed relay manufacturing capability via our sister company, Pickering Electronics. These instrument grade reed relays feature **SoftCenter®** technology, ensuring long service life and repeatable contact performance.

To learn more, please go to: [pickeringrelay.com](http://pickeringrelay.com)





## Programming

Pickering provide kernel, IVI and VISA (NI & Keysight) drivers which are compatible with all Microsoft supported versions of Windows and popular older versions. For a list of all supporting operating systems, please see: [pickeringtest.com/os](http://pickeringtest.com/os)

The VISA driver is also compatible with Real-Time Operating Systems such as LabVIEW RT. For other RTOS support contact Pickering. These drivers may be used with a variety of programming environments and applications including:

- **Pickering Interfaces Switch Path Manager**
- **National Instruments** products (LabVIEW, LabWindows/CVI, Switch Executive, MAX, TestStand, VeriStand, etc.)
- **Microsoft Visual Studio** products (Visual Basic, Visual C+)
- **Keysight** VEE and OpenTAP
- **Mathworks** Matlab
- **Marvin** ATEasy
- **MTQ Testolutions** Tecap Test & Measurement Suite

Drivers for popular Linux distributions are available, other environments are also supported, please contact Pickering with specific enquiries. We provide Soft Front Panels (SFPs) for our products for familiarity and manual control, as well as comprehensive documentation and example programs to help you develop test routines with ease.

To learn more about software drivers and development environments, please go to:

[pickeringtest.com/software](http://pickeringtest.com/software)

## Signal Routing Software

Our signal routing software, Switch Path Manager, automatically selects and energizes switch paths through Pickering switching systems. Signal routing is performed by simply defining test system endpoints to be connected together, greatly accelerating Test System software development. To learn more, please go to: [pickeringtest.com/spm](http://pickeringtest.com/spm)

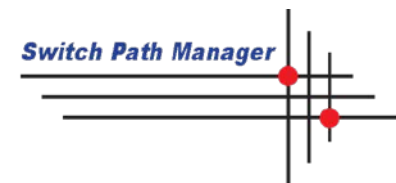

## Diagnostic Relay Test Tools

eBIRST Switching System Test Tools are designed specifically for our PXI, PCI or LXI products, these tools simplify switching system fault-finding by quickly testing the system and graphically identifying the faulty relay.

To learn more, please go to: [pickeringtest.com/ebirst](http://pickeringtest.com/ebirst)



## Three Year Warranty & Guaranteed Long-Term Support

All standard products manufactured by Pickering Interfaces are warranted against defective materials and workmanship for a period of three years from the date of delivery to the original purchaser. Extended warranty and service agreements are available for all our modules and systems with various levels to suit your requirements. Although we offer a 3-year warranty as standard, we also include guaranteed long-term support—with a history of supporting our products for typically 15-20 years. To learn more, please go to: [pickeringtest.com/support](http://pickeringtest.com/support)

## Available Product Resources

We have a large library of product resources including success stories, product and support videos, articles, as well as complete product catalogs and product reference maps to assist when looking for the switching, simulation and cable and connector solutions you need. We have also published handy reference books on Switching Technology and for the PXI and LXI standards.

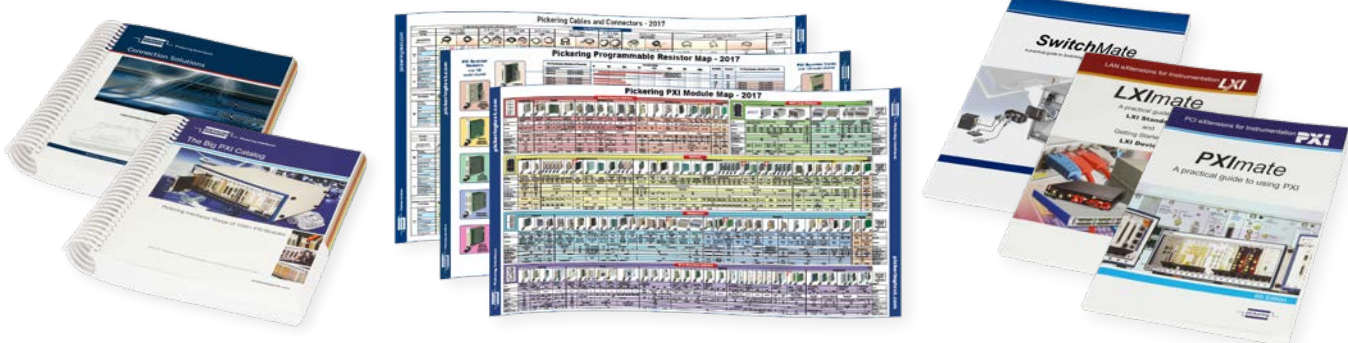

To view, download or request any of our product resources, please visit: [pickeringtest.com/resources](http://pickeringtest.com/resources)