

- High Density, High Current Switching
- Optional Loop-Thru Connections
- 4x4 or 8x2 1-Pole Matrix
- 16A Maximum Switch Current
- Switch up to 300VDC or 250VAC
- 448W/4000VA Maximum Power
- 400VDC Standoff Voltage
- VISA, IVI & Kernel Drivers Supplied for Windows
- Supported by PXI or LXI Chassis
- 3 Year Warranty

The 40-552 is a power matrix, suitable for switching loads up to 16A at 250VAC. The module is available in the following configurations:

- 40-552-001 4x4 1-Pole 10A Matrix
- 40-552-002 8x2 1-Pole 10A Matrix
- 40-552-011 4x4 1-Pole 10A Matrix with Y Loop-Thru
- 40-552-012 8x2 1-Pole 10A Matrix with Y Loop-Thru

Versions with Y loop-thru allow expansion between adjacent 40-552 modules, for example 8x4 or 16x2 matrices can easily be created.

Power matrix modules are intended for switching heavy AC or DC loads or for the slave switching of large external relays, contactors and solenoids.



**20-pin 16 Amp Power Connector**

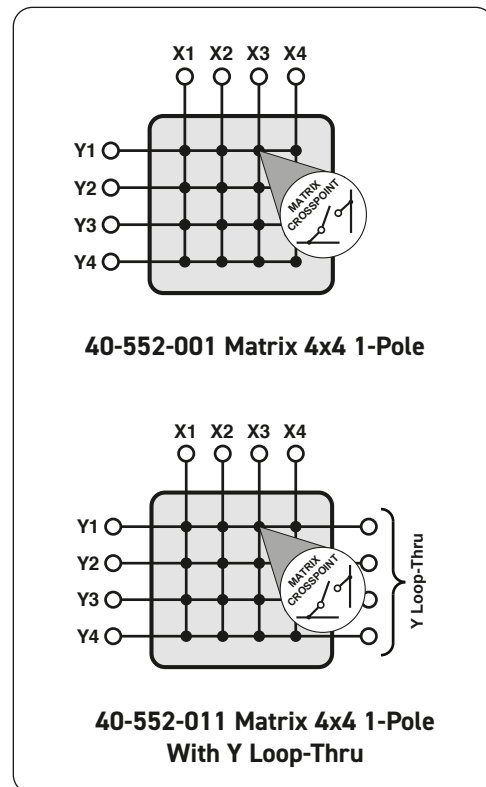
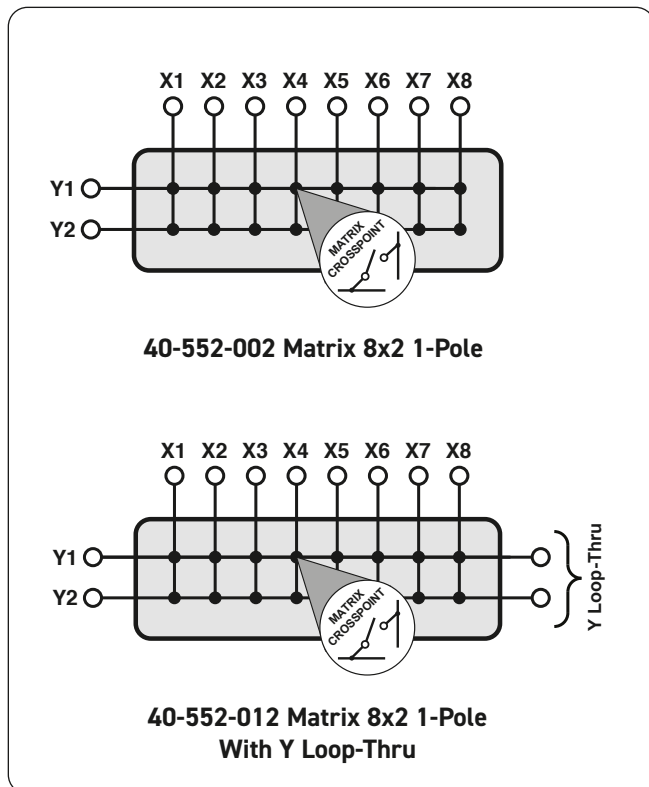

## Matrix Expansion

The 40-552 may be expanded to larger matrix sizes using cabling to daisy-chain the Y signals.

The first illustration below shows two 40-552-011 4x4 matrices connected as an 8x4 matrix using a GMCT to GMCT cable wired with Y to Y connections. The second illustration shows two 40-552-012 8x2 matrices connected as a 16x2 matrix using a GMCT to GMCT cable wired with Y to Y connections.

Pickering Interfaces is able to design and supply custom cables incorporating loop-thru connections that interface to the connectors of a user's test system. Please contact your local Pickering sales office with your requirements.

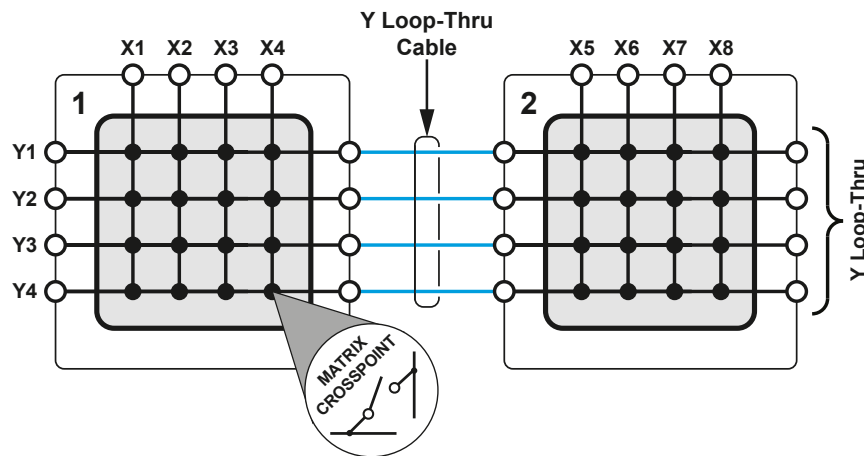

**Schematic Diagram of two 40-552-011 matrices connected as a single 8x4 1-pole matrix, using the loop-thru connection for linking Y to Y.**

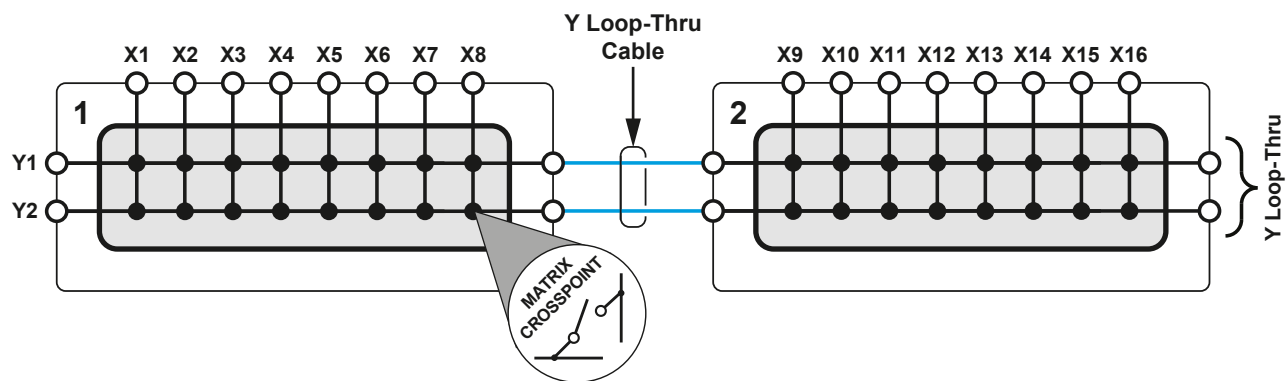

**Schematic Diagram of two 40-552-012 matrices connected as a single 16x2 1-pole matrix, using the loop-thru connection for linking Y to Y.**

## Relay Type

The 40-552 is fitted with electro-mechanical power relays with silver alloy contacts. A spare relay is built onto the circuit board to allow easy maintenance with minimum downtime.

## Switching Specification

|   |   |
|---|---|
| Contact Type:                                 | Silver Alloy (AgNi)   |
| Cold Switching Capacity                       |   |
| Maximum Current:                              | 16A   |
| Maximum Voltage:                              | 400VDC/250VAC*  |
| Hot Switching Capacity (Resistive Load)       |   |
| Maximum Current:                              | 16A   |
| Maximum Voltage:                              | 300VDC/250VAC*  |
| Maximum Power:                                | 448W/4000VA   |
| Minimum Switching Capacity:                   | 100mA, 12V  |
| Maximum Continuous Total Switch Path Loading: | Can carry 16A on all matrix paths at the same time                                |
| Module Thermal Time Constant:                 | 4 minutes typical   |
| Maximum Standoff Voltage:                     | 400VDC  |
| Initial Path Resistance, On:                  | <30mΩ (12mΩ typical)  |
| Path Resistance, Off:                         | >10 <sup>9</sup> Ω  |
| Bandwidth:                                    | >8MHz   |
| Typical Operate Time:                         | 10ms  |
| Expected Life (operations)                    |   |
| Mechanical Endurance:                         | >3x10 <sup>7</sup>  |
| Maximum Switch Capacity (Resistive Load)      |   |
| 16A @ 250VAC (4000VA):                        | 1x10 <sup>5</sup>   |
| 8A @ 30VDC (240W):                            | >1x10 <sup>5</sup> (NC/NO Contacts, Frequency of Operation 0.1Hz, Duty Cycle 90%) |
| 16A @ 28VDC (448W):                           | >1x10 <sup>5</sup> (NC/NO Contacts, Frequency of Operation 0.1Hz, Duty Cycle 90%) |

\* For full voltage rating, signal sources to be switched must be fully isolated from mains supply and safety earth.

## Power Requirements

|       |          |      |      |
|-------|----------|------|------|
| +3.3V | +5V      | +12V | -12V |
| 0     | 1.4A max | 0    | 0    |

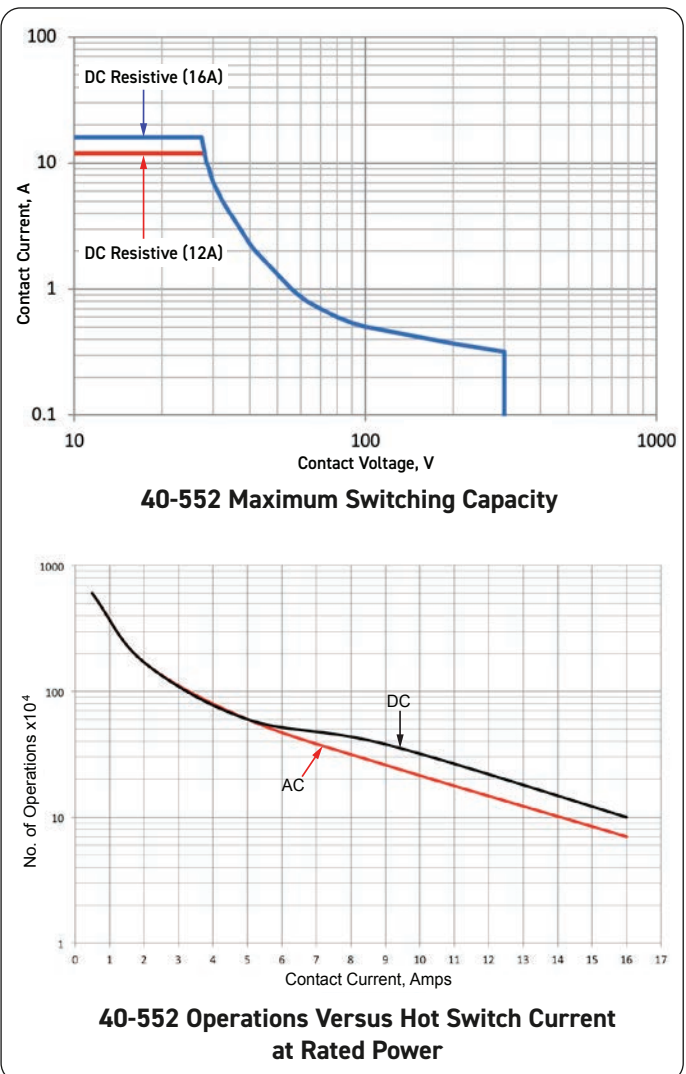

## Mechanical Characteristics

Single slot 3U PXI (CompactPCI card).  
 Module weight: 420g (typical).  
 3D models for all versions in a variety of popular file formats are available on request.

## Connectors

PXI bus via 32-bit P1/J1 backplane connector.  
 Signals via front panel 20-pin male GMCT connector, for pin outs please refer to the operating manual.

## Operating/Storage Conditions

### Operating Conditions

Operating Temperature: 0°C to +55°C  
 Humidity: Up to 90% non-condensing  
 Altitude: 5000m

### Storage and Transport Conditions

Storage Temperature: -20°C to +75°C  
 Humidity: Up to 90% non-condensing  
 Altitude: 15000m

## Product Order Codes

---

### Matrix Modules:

**4x4, 1-Pole 16A Power Matrix**                      **40-552-001**

**8x2, 1-Pole 16A Power Matrix**                      **40-552-002**

---

### Matrix Modules with Y Loop-Thru Option:

**4x4, 1-Pole 16A Power Matrix with Y LT**      **40-552-011**

**8x2, 1-Pole 16A Power Matrix with Y LT**      **40-552-012**

---

## Product Customization

Pickering PXI modules are designed and manufactured on our own flexible manufacturing lines, giving complete product control and enabling simple customization to meet very specific requirements.

Customization can include:

- Alternative relay types
- Mixture of relay types
- Alternative number of relays
- Different performance specifications

All customized products are given a unique part number, fully documented and may be ordered at any time in the future. Please contact your local sales office to discuss.

## PXI & CompactPCI Compliance

The module is compliant with the PXI Specification 2.2. Local Bus, Trigger Bus and Star Trigger are not implemented.

Uses a 33MHz 32-bit backplane interface.

## Safety & CE Compliance

All modules are fully CE compliant and meet applicable EU directives: Low-voltage safety EN61010-1:2010, EMC Immunity EN61326-1:2013, Emissions EN55011:2009+A1:2010.

## Support Products

---

### Spare Relay Kits

Kits of replacement relays are available for the majority of Pickering's PXI switching products, simplifying servicing and reducing down-time.

| Product       | Relay Kit         |
|---------------|-------------------|
| <b>40-552</b> | <b>91-100-092</b> |

For further assistance, please contact your local Pickering sales office.

---

## Mating Connectors & Cabling

---

For connection accessories for the 40-552 module please refer to the [90-014D](#) 20-pin GMCT Connector Accessories data sheet where a complete list and documentation can be found for accessories, or refer to the Connection Solutions catalog.

---

## Chassis Compatibility

This PXI module must be used in a suitable chassis. It is compatible with the following chassis types:

- All chassis conforming to the 3U PXI and 3U Compact PCI (cPCI) specification
- Legacy and Hybrid Peripheral slots in a 3U PXI Express (PXIe) chassis
- Pickering Interfaces LXI or LXI/USB Modular Chassis

## Chassis Selection Guide

### Standard PXI or hybrid PXIe Chassis from any Vendor:

- Mix our 1000+ PXI switching & simulation modules with any vendor's PXI instrumentation
- Embedded or remote Windows PC control
- Real-time Operating System Support
- High data bandwidths, especially with PXI Express
- Integrated module timing and synchronization



### Pickering LXI or LXI/USB Modular Chassis—only accept our 1000+ PXI Switching & Simulation Modules:

- Ethernet or USB control enables remote operation
- Low-cost control from practically any controller
- LXI provides manual control via Web browsers
- Driverless software support
- Power sequencing immunity
- Ethernet provides chassis/controller voltage isolation
- Independence from Windows operating system



## Connectivity Solutions

We provide a full range of supporting cable and connector solutions for all our switching products—20 connector families with 1200+ products. We offer everything from simple mating connectors to complex cables assemblies and terminal blocks. All assemblies are manufactured by Pickering and are guaranteed to mechanically and electrically mate to our modules.



Connectors & Backshells



Multiwire Cable Assemblies

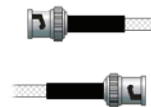

RF Cable Assemblies



Connector Blocks

We also offer customized cabling and have a free online **Cable Design Tool** that can be used to create custom cable solutions for many applications. Visit: [pickeringtest.com/cdt](http://pickeringtest.com/cdt) to start your design.

## Mass Interconnect

We recommend the use of a mass interconnect solution when an Interchangeable Test Adapter (ITA) is required for a PXI or LXI based test system. Our modules are fully supported by both Virginia Panel and MacPanel.



## Pickering Reed Relays

We are the only switch provider with in-house reed relay manufacturing capability via our Relay Division. These instrument grade reed relays feature **SoftCenter™** technology, ensuring long service life and repeatable contact performance. To learn more, please go to: [pickeringrelay.com](http://pickeringrelay.com)



## Programming

Pickering provide kernel, IVI and VISA (NI & Keysight) drivers which are compatible with all Microsoft supported versions of Windows and popular older versions. For a list of all supporting operating systems, please see: [pickeringtest.com/os](http://pickeringtest.com/os)

The VISA driver support is provided for LabVIEW Real Time Operating Systems (Pharlap and Linux-RT). For other RTOS support contact Pickering. These drivers may be used with a variety of programming environments and applications including:

- **Pickering Interfaces Switch Path Manager**
- **National Instruments** products (LabVIEW, LabWindows/CVI, Switch Executive, MAX, TestStand, VeriStand, etc.)
- **Microsoft Visual Studio** products (Visual Basic, Visual C++)
- **Programming Languages** C, C++, C#, Python
- **Keysight** VEE and OpenTAP
- **Mathworks** Matlab
- **Marvin** ATEasy
- **MTQ Testsolutions** Tecap Test & Measurement Suite

Drivers for popular Linux distributions are available, other environments are also supported, please contact Pickering with specific enquiries. We provide Soft Front Panels (SFPs) for our products for familiarity and manual control, as well as comprehensive documentation and example programs to help you develop test routines with ease.

To learn more about software drivers and development environments, please go to: [pickeringtest.com/software](http://pickeringtest.com/software)

## Signal Routing Software

Our signal routing software, Switch Path Manager, automatically selects and energizes switch paths through Pickering switching systems. Signal routing is performed by simply defining test system endpoints to be connected together, greatly accelerating Test System software development. To learn more, please go to: [pickeringtest.com/spm](http://pickeringtest.com/spm)

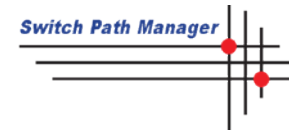

## Diagnostic Relay Test Tools

**eBIRST** Switching System Test Tools are designed specifically for our PXI, PCI or LXI products, these tools simplify switching system fault-finding by quickly testing the system and graphically identifying the faulty relay.

To learn more, please go to: [pickeringtest.com/ebirst](http://pickeringtest.com/ebirst)



## Three Year Warranty & Guaranteed Long-Term Support

All standard products manufactured by Pickering Interfaces are warranted against defective materials and workmanship for a period of three years from the date of delivery to the original purchaser. Extended warranty and service agreements are available for all our modules and systems with various levels to suit your requirements. Although we offer a 3-year warranty as standard, we also include guaranteed long-term support—with a history of supporting our products for typically 15-20 years. To learn more, please go to: [pickeringtest.com/support](http://pickeringtest.com/support)

## Available Product Resources

We have a large library of product resources including success stories, product and support videos, articles and white papers as well as application specific product brochures to assist when looking for the switching, simulation and connection solutions you need. We also have handy reference books on Switching Technology and for the PXI and LXI standards.



To view, download or request any of our product resources, please visit: [pickeringtest.com/resources](http://pickeringtest.com/resources)