

- 1 or 2 Transfer Switches Per Module
- 50 Ω Characteristic Impedance
- 18 GHz, 26.5 GHz, 40 GHz & 50 GHz Options
- LED Indication
- VISA, IVI & Kernel Drivers Supplied for Windows
- Supported by PXI or LXI Chassis
- 3 Year Warranty

The 40-782A module has one or two microwave transfer switches with a characteristic impedance of 50 Ω and is available in 18 GHz, 26.5 GHz, 40 GHz or 50 GHz versions. Connections are made via front panel mounted high quality SMA, SMA 2.9 or SMA 2.4 coaxial connectors, depending upon the frequency range.

Transfer switches have four ports with two switch states. In the default (de-energized) state, ports 1 to 2 and 3 to 4 have signal paths between them. In the energized state the signal paths are between ports 1 to 3 and 2 to 4 (see diagrams).

These modules give you the highest RF and microwave switching performance available within a Pickering switching system. Although designed for microwave applications, they have many uses in the RF spectrum where extremely low insertion loss and ultra high isolation are critical. They may also be used for lower frequency applications where power handling to 240W is required.

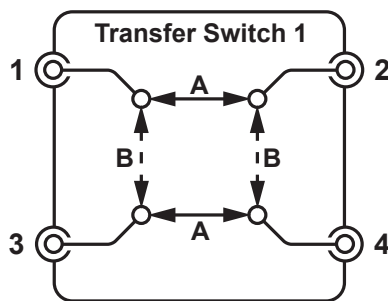

Position A: 1 to 2, 3 to 4
Position B: 1 to 3, 2 to 4

**Schematic of 40-782A
Single Microwave Transfer Switch**

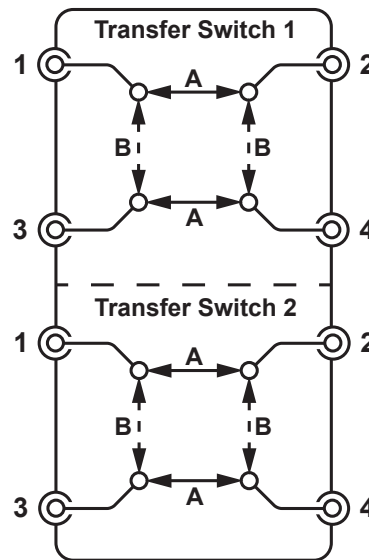

Position A: 1 to 2, 3 to 4
Position B: 1 to 3, 2 to 4

**Schematic of 40-782A
Dual Microwave Transfer Switch**

General Specification

Configuration:	Microwave Transfer Switch, 1 or 2 independent banks.
LED Indicators:	Blue LEDs to indicate activated relays.
Operate Time:	15 ms
Characteristic Impedance:	50 Ω
Expected Life (18 GHz, 26.5 GHz & 40 GHz versions):	>2.5 million operations

RF Specification - 18 GHz and 26.5 GHz Versions

Connectors:	SMA
Insertion Loss:	<0.2 dB to 3 GHz <0.3 dB to 8 GHz <0.4 dB to 12.4 GHz <0.5 dB to 18 GHz <0.7 dB to 26.5 GHz (26.5 GHz versions only)
Isolation:	>80 dB to 3 GHz >70 dB to 8 GHz >65 dB to 12.4 GHz >60 dB to 18 GHz >50 dB to 26.5 GHz (26.5 GHz versions only)
VSWR:	<1.2:1 to 3 GHz <1.3:1 to 8 GHz <1.4:1 to 12.4 GHz <1.5:1 to 18 GHz <1.7:1 to 26.5 GHz (26.5 GHz versions only)
RF Average Carry	
Power at 25 °C:	240 W to 3 GHz 150 W to 8 GHz 120 W to 12.4 GHz 100 W to 18 GHz 40 W to 26.5 GHz (26.5 GHz versions only)

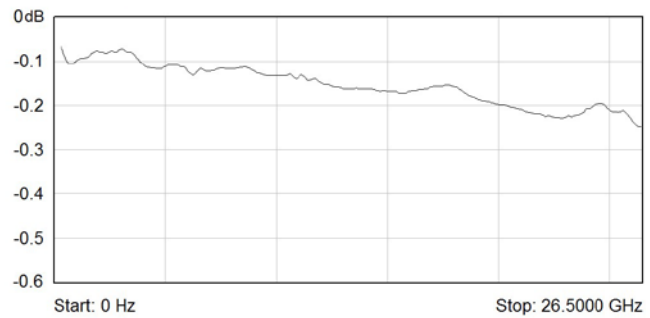

Insertion Loss Plot for 26.5 GHz Versions

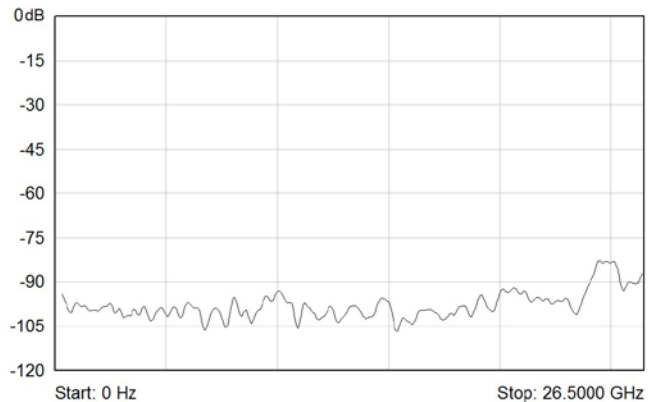

Isolation Plot for 26.5 GHz Versions

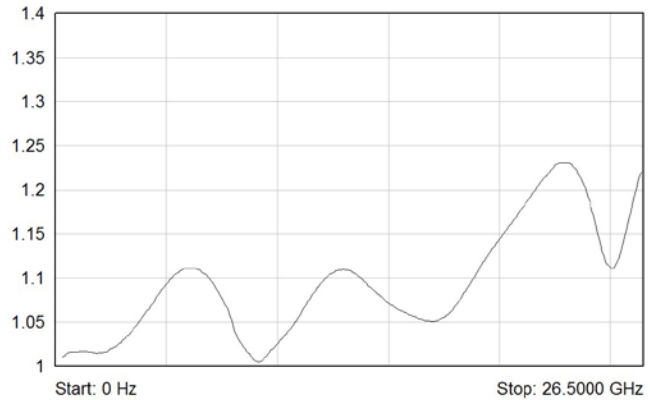

VSWR Plot for 26.5 GHz Versions

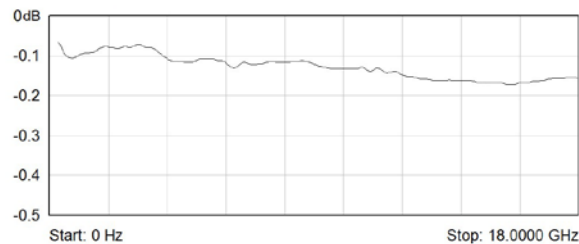

Insertion Loss Plot for 18 GHz Versions

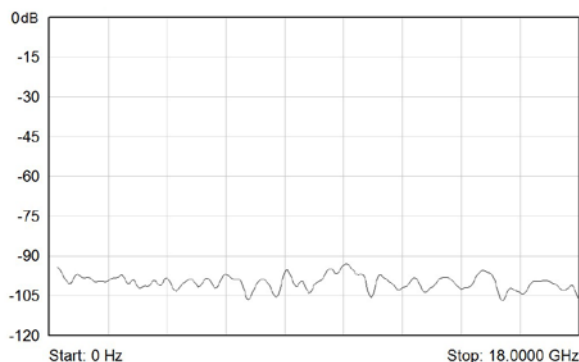

Isolation Plot for 18 GHz Versions

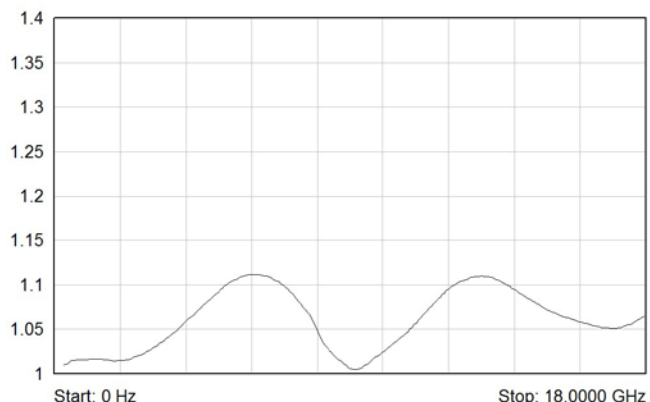

VSWR Plot for 18 GHz Versions

Additional Specification for 40 GHz Versions

Connectors:	SMA-2.9
Insertion Loss:	<0.8 dB to 40 GHz
Isolation:	>50 dB to 40 GHz
VSWR:	<1.9:1 to 40 GHz
RF Average Carry Power at 25°C:	80 W to 6 GHz 60 W to 12.4 GHz 50 W to 18 GHz 20 W to 26.5 GHz 10 W to 40 GHz

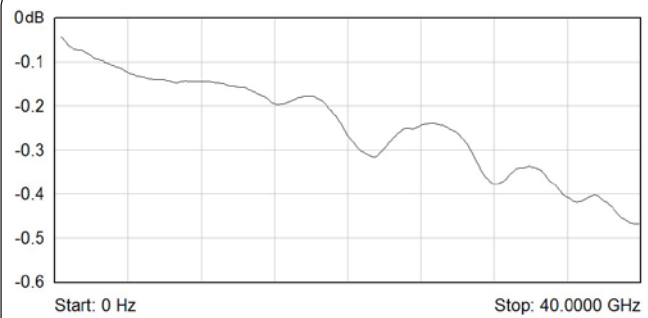

Insertion Loss Plot for 40 GHz Versions

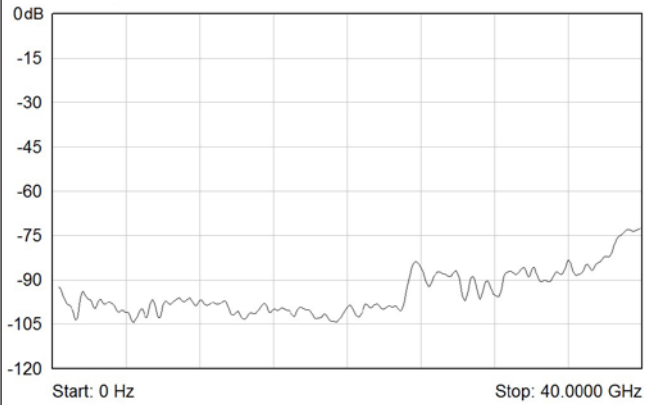

Isolation Plot for 40 GHz Versions

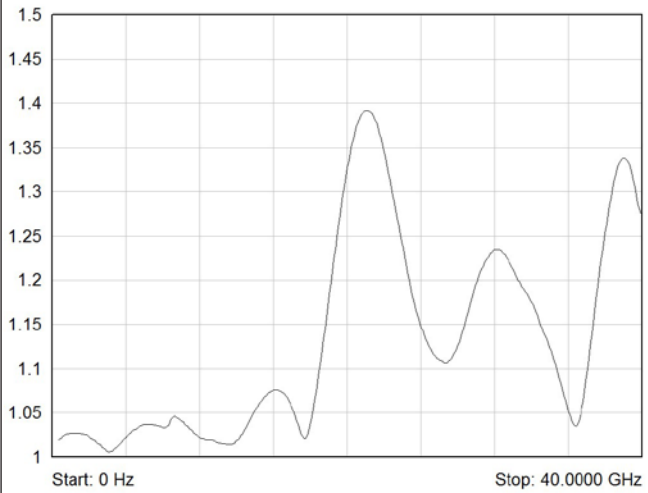

VSWR Plot for 40 GHz Versions

Additional Specification for 50 GHz Versions

Connectors:	SMA-2.4
Insertion Loss:	<0.3 dB to 6 GHz <0.4 dB to 12.4 GHz <0.5 dB to 18 GHz <0.7 dB to 26.5 GHz <0.8 dB to 40 GHz <1.1 dB to 50 GHz
Isolation:	>70 dB to 6 GHz >60 dB to 12.4 GHz >60 dB to 18 GHz >55 dB to 26.5 GHz >50 dB to 40 GHz >50 dB to 50 GHz
VSWR:	<1.3:1 to 6 GHz <1.4:1 to 12.4 GHz <1.5:1 to 18 GHz <1.7:1 to 26.5 GHz <1.9:1 to 40 GHz <2.0:1 to 50 GHz
RF Average Carry Power at 25°C:	80 W to 6 GHz 60 W to 12.4 GHz 50 W to 18 GHz 20 W to 26.5 GHz 10 W to 40 GHz 5 W to 50 GHz
Expected Life:	2 million operations

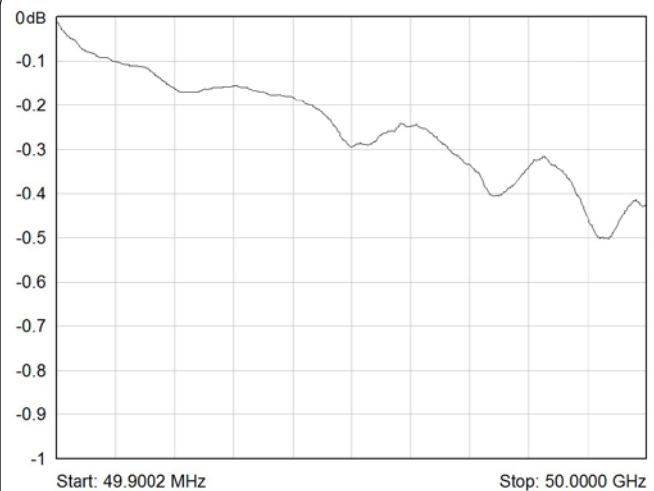

Insertion Loss Plot for 50 GHz Versions

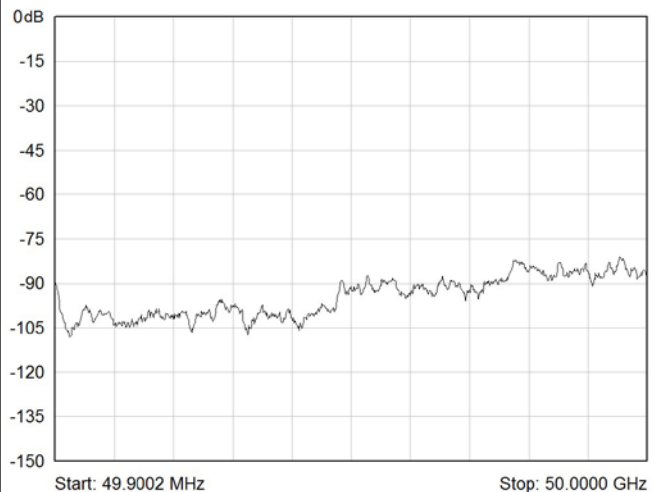

Isolation Plot for 50 GHz Versions

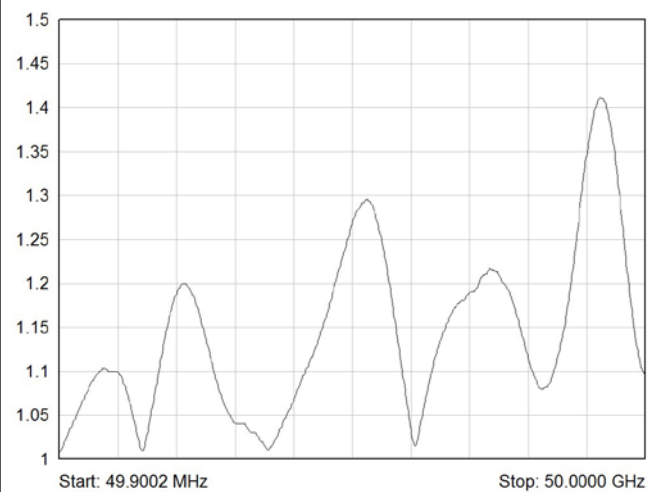

VSWR Plot for 50 GHz Versions

Power Requirements

+3.3V	+5V	+12V	-12V
0.1 A	0.2 A	0.7 A	0

Mechanical Characteristics

Single and dual slot 3U PXI (CompactPCI card).
 Module weight: 200 g (40-782A-522).
 3D models for all versions in a variety of popular file formats are available on request.

Connectors

PXI bus via 32-bit P1/J1 backplane connector.
 Signals via front panel mounted coaxial connectors.

Operating/Storage Conditions

Operating Conditions

Operating Temperature: 0 °C to +55 °C
 Humidity: Up to 90 % non-condensing
 Altitude: 5000 m

Storage and Transport Conditions

Storage Temperature: -20 °C to +75 °C
 Humidity: Up to 90 % non-condensing
 Altitude: 15000 m

PXI & CompactPCI Compliance

The module is compliant with the PXI Specification 2.2.
 Local Bus, Trigger Bus & Star Trigger are not implemented.
 Uses a 33 MHz 32-bit backplane interface.

Safety & CE Compliance

All modules are fully CE compliant and meet applicable EU directives: Low-voltage safety EN61010-1:2010, EMC Immunity EN61326-1:2013, Emissions EN55011:2009+A1:2010.

Product Order Codes

18 GHz Microwave Transfer Switch:

1 x Transfer Switch, 50 Ω SMA **40-782A-521**
 2 x Transfer Switch, 50 Ω SMA **40-782A-522**

26.5 GHz Microwave Transfer Switch:

1 x Transfer Switch, 50 Ω SMA **40-782A-531**
 2 x Transfer Switch, 50 Ω SMA **40-782A-532**

40 GHz Microwave Transfer Switch:

1 x Transfer Switch, 50 Ω SMA-2.9 **40-782A-541**
 2 x Transfer Switch, 50 Ω SMA-2.9 **40-782A-542**

50 GHz Microwave Transfer Switch:

1 x Transfer Switch, 50 Ω SMA-2.4 **40-782A-551**
 2 x Transfer Switch, 50 Ω SMA-2.4 **40-782A-552**

Product Customization

Pickering modules are designed and manufactured on our own flexible manufacturing lines, giving complete product control and enabling simple customization to meet very specific requirements.

Customization can include:

- Alternative relay types
- Mixture of relay types
- Alternative number of relays
- Different performance specifications

All customized products are given a unique part number, fully documented and may be ordered at any time in the future. Please contact your local sales office to discuss.

Mating Connectors & Cabling

For connection accessories for the 40-782A series please refer to the [90-011D](#) RF Cable Assemblies data sheet where a complete list and documentation can be found for accessories, or refer to the Connection Solutions catalog.

Warranty

This module carries a 3 year warranty. The warranty specifically applies to only the cold switching operations of the relay within the stated lifetime.

Chassis Compatibility

This PXI module must be used in a suitable chassis. It is compatible with the following chassis types:

- All chassis conforming to the 3U PXI and 3U Compact PCI (cPCI) specification
- Legacy and Hybrid Peripheral slots in a 3U PXI Express (PXIe) chassis
- Pickering Interfaces LXI or LXI/USB Modular Chassis

Chassis Selection Guide

Standard PXI or hybrid PXIe Chassis from any Vendor:

- Mix our 1000+ PXI switching & simulation modules with any vendor's PXI instrumentation
- Embedded or remote Windows PC control
- Real-time Operating System Support
- High data bandwidths, especially with PXI Express
- Integrated module timing and synchronization

Pickering LXI or LXI/USB Modular Chassis—only accept our 1000+ PXI Switching & Simulation Modules:

- Ethernet or USB control enables remote operation
- Low-cost control from practically any controller
- LXI provides manual control via Web browsers
- Driverless software support
- Power sequencing immunity
- Ethernet provides chassis/controller voltage isolation
- Independence from Windows operating system



Connectivity Solutions

We provide a full range of supporting cable and connector solutions for all our switching products—20 connector families with 1200+ products. We offer everything from simple mating connectors to complex cables assemblies and terminal blocks. All assemblies are manufactured by Pickering and are guaranteed to mechanically and electrically mate to our modules.



Connectors & Backshells



Multiwire Cable Assemblies

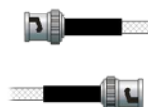

RF Cable Assemblies



Connector Blocks

We also offer customized cabling and have a free online **Cable Design Tool** that can be used to create custom cable solutions for many applications. Visit: pickeringtest.com/cdt to start your design.

Mass Interconnect

We recommend the use of a mass interconnect solution when an Interchangeable Test Adapter (ITA) is required for a PXI or LXI based test system. Our modules are fully supported by both Virginia Panel and MacPanel.

Pickering Reed Relays

We are the only switch provider with in-house reed relay manufacturing capability via our Relay Division. These instrument grade reed relays feature **SoftCenter™** technology, ensuring long service life and repeatable contact performance. To learn more, please go to: pickeringrelay.com



Programming

Pickering provide kernel, IVI and VISA (NI & Keysight) drivers which are compatible with all Microsoft supported versions of Windows and popular older versions. For a list of all supporting operating systems, please see: pickeringtest.com/os

The VISA driver is also compatible with Real-Time Operating Systems such as LabVIEW RT. For other RTOS support contact Pickering. These drivers may be used with a variety of programming environments and applications including:

- **Pickering Interfaces Switch Path Manager**
- **National Instruments** products (LabVIEW, LabWindows/CVI, Switch Executive, MAX, TestStand, VeriStand, etc.)
- **Microsoft Visual Studio** products (Visual Basic, Visual C+)
- **Keysight** VEE and OpenTAP
- **Mathworks** Matlab
- **Marvin** ATEasy
- **MTQ Testsolutions** Tecap Test & Measurement Suite

Drivers for popular Linux distributions are available, other environments are also supported, please contact Pickering with specific enquiries. We provide Soft Front Panels (SFPs) for our products for familiarity and manual control, as well as comprehensive documentation and example programs to help you develop test routines with ease.

To learn more about software drivers and development environments, please go to: pickeringtest.com/software

Signal Routing Software

Our signal routing software, Switch Path Manager, automatically selects and energizes switch paths through Pickering switching systems. Signal routing is performed by simply defining test system endpoints to be connected together, greatly accelerating Test System software development. To learn more, please go to: pickeringtest.com/spm

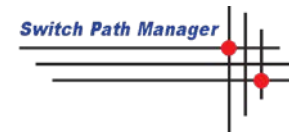

Diagnostic Relay Test Tools

eBIRST Switching System Test Tools are designed specifically for our PXI, PCI or LXI products, these tools simplify switching system fault-finding by quickly testing the system and graphically identifying the faulty relay.

To learn more, please go to: pickeringtest.com/ebirst



Three Year Warranty & Guaranteed Long-Term Support

All standard products manufactured by Pickering Interfaces are warranted against defective materials and workmanship for a period of three years from the date of delivery to the original purchaser. Extended warranty and service agreements are available for all our modules and systems with various levels to suit your requirements. Although we offer a 3-year warranty as standard, we also include guaranteed long-term support—with a history of supporting our products for typically 15-20 years. To learn more, please go to: pickeringtest.com/support

Available Product Resources

We have a large library of product resources including success stories, product and support videos, articles and white papers as well as application specific product brochures to assist when looking for the switching, simulation and connection solutions you need. We have also published handy reference books on Switching Technology and for the PXI and LXI standards.



To view, download or request any of our product resources, please visit: pickeringtest.com/resources