



- High Performance 6-Channel RF Multiplexers
- 6 GHz, 18 GHz, 26.5 GHz and 40 GHz Bandwidths
- Up to 16 Multiplexer Banks
- Excellent RF & Repeatability Characteristics
- Extended Life For 6 GHz/18 GHz/26.5 GHz Models - 10 M Operations Guaranteed & Typically >25 M!

- LED Indication
- Compact 1U or 2U Form Factor
- LXI Standard 1.5 Compliant
- IVI & Direct I/O Drivers
- 3 Year Warranty

The 60-801 Microwave Multiplexer is suitable for switching 50 Ω signals up to 40 GHz. With up to 16 banks of 6 channels it is ideal for constructing complex microwave switching systems for many applications. Connection is by front panel mounted SMA or SMA-2.9 connectors.

The multiplexer has an extremely high level of performance with low VSWR, very high isolation, low loss and high power handling. It is ideal for switching 50 Ω systems for HF up to microwave frequencies. It occupies 1U (1-8 bank versions) or 2U (9-16 bank versions) of rack space, providing a compact switching solution. Multiplexers can be user connected to create customized switching systems which include both multiplexer and matrix arrangements.

Controlling the Multiplexer

The 60-801 is controlled through an LXI interface based on Ethernet 1000Base-T. This provides a quick and easy method of installing the 60-801 and a simple way of controlling the unit from a remote location through its API or built in soft front panel. The ability to control the unit at a distance allows the testing of systems without the need for a physical presence.

Easy Repair

To allow fast in field repair, unterminated relays may be individually replaced without removing the covers from the chassis or the chassis from the host rack.

Other Microwave Switching Configurations

We are able to offer other microwave switching solutions, if you have a custom requirement for switching please contact your local Pickering Interfaces sales representative.

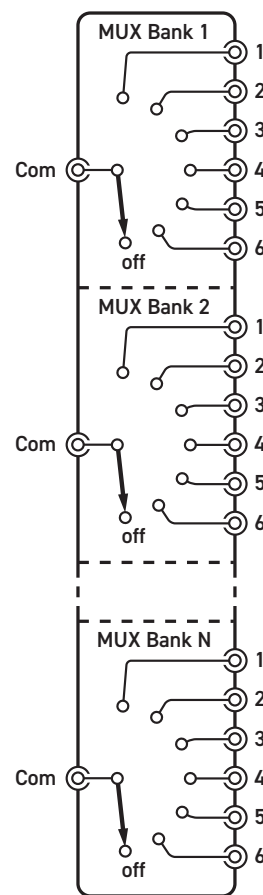

Schematic Diagram for the 60-801 Microwave MUX - up to 16 Multiplexer Modules can be supported

General Multiplexer Information

Relay Manufacturer:	Radiall
Configuration:	SP6T Microwave Multiplexer with up to 16 independent banks.
LED Indicators:	Multiplexers have blue LEDs to indicate a closed RF path.
Operate Time:	Typically <13 ms
Maximum Cold Switch Voltage:	100 V*
Maximum Carry Current:	1A

* For full voltage rating, signal sources to be switched must be fully isolated from mains supply and safety earth.

Multiplexer Specification - 6 GHz Versions

Characteristic Impedance:	50 Ω
Connectors:	SMA
Bandwidth:	DC to 6 GHz
Maximum RF Carry Power:	250 W (0-3 GHz) 150 W (3-6 GHz)
Isolation:	>80 dB (0-3 GHz) >70 dB (3-6 GHz)
Insertion Loss:	<0.2 dB (0-3 GHz) <0.3 dB (3-6 GHz)
VSWR:	<1:1.2 (0-3 GHz) <1:1.3 (3-6 GHz)
Expected Life (low power):	>10 million operations per position guaranteed (typically >25 million)
Insertion Loss Repeatability:	Within 0.01 dB

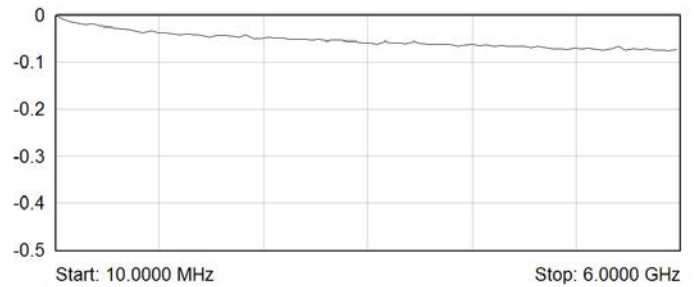

Typical Insertion Loss (dB) Plot for 6 GHz Versions

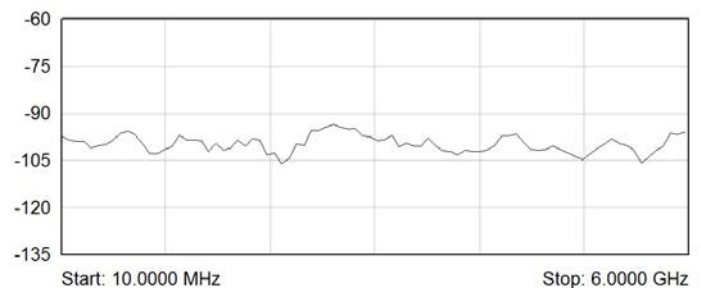

Typical Isolation (dB) Plot for 6 GHz Versions

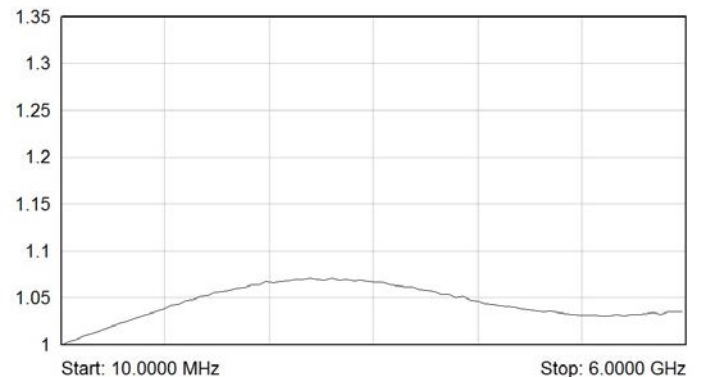

Typical VSWR Plot for 6 GHz Versions

Multiplexer Specification - 18 GHz Versions

Characteristic Impedance:	50 Ω
Connectors:	SMA
Bandwidth:	DC to 18 GHz
Maximum RF Carry Power:	250 W (0-3 GHz) 150 W (3-8 GHz) 120 W (8-12.4 GHz) 100 W (12.4-18 GHz)
Isolation:	>80 dB (0-3 GHz) >70 dB (3-8 GHz) >60 dB (8-12.4 GHz) >60 dB (12.4-18 GHz)
Insertion Loss:	<0.2 dB (0-3 GHz) <0.3 dB (3-8 GHz) <0.4 dB (8-12.4 GHz) <0.5 dB (12.4-18 GHz)
VSWR:	<1:1.2 (0-3 GHz) <1:1.3 (3-8 GHz) <1:1.4 (8-12.4 GHz) <1:1.5 (12.4-18 GHz)
Expected Life (low power):	>10 million operations per position guaranteed (typically >25 million)
Insertion Loss Repeatability:	Within 0.025 dB
Propagation Delay Variation (between channels):	<1 ps

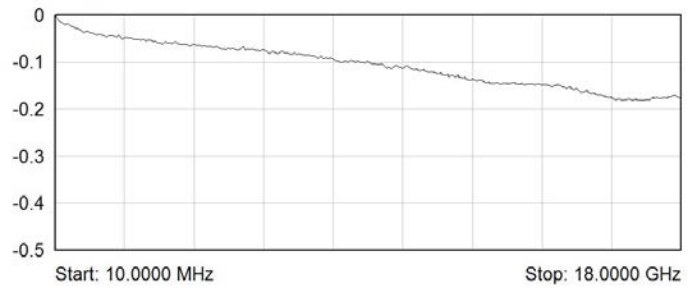

Typical Insertion Loss (dB) Plot for 18 GHz Versions

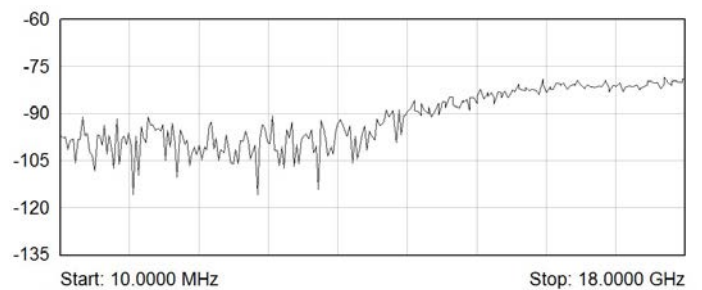

Typical Isolation (dB) Plot for 18 GHz Versions

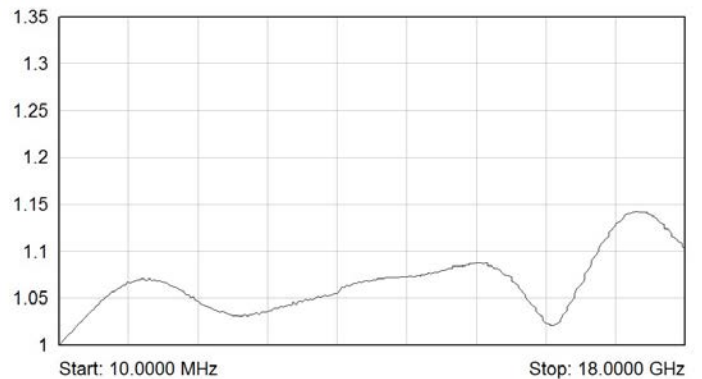

Typical VSWR Plot for 18 GHz Versions

Multiplexer Specification - 26.5 GHz Versions

Characteristic Impedance:	50 Ω
Connectors:	SMA
Bandwidth:	DC to 26.5 GHz
Maximum RF Carry Power:	250 W (0-3 GHz) 150 W (3-8 GHz) 120 W (8-12.4 GHz) 100 W (12.4-18 GHz) 40 W (18-26.5 GHz)
Isolation:	>80 dB (0-3 GHz) >70 dB (3-8 GHz) >60 dB (8-12.4 GHz) >60 dB (12.4-18 GHz) >55 dB (18-26.5 GHz)
Insertion Loss:	<0.2 dB (0-3 GHz) <0.3 dB (3-8 GHz) <0.4 dB (8-12.4 GHz) <0.5 dB (12.4-18 GHz) <0.6 dB (18-26.5 GHz)
VSWR:	<1:1.2 (0-3 GHz) <1:1.3 (3-8 GHz) <1:1.4 (8-12.4 GHz) <1:1.5 (12.4-18 GHz) <1:1.6 (18-26.5 GHz)
Expected Life (low power):	>10 million operations per position guaranteed (typically >25 million)
Insertion Loss Repeatability:	Within 0.035 dB

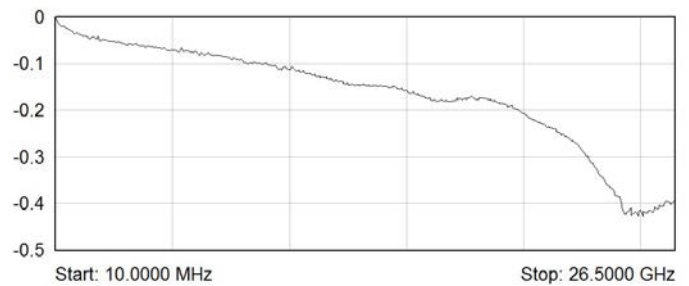

Typical Insertion Loss (dB) Plot for 26.5 GHz Versions

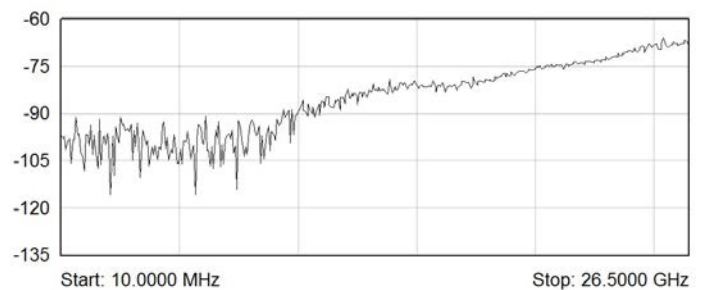

Typical Isolation (dB) Plot for 26.5 GHz Versions

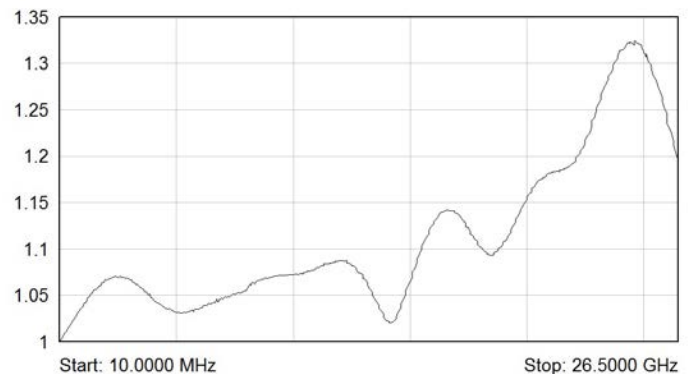

Typical VSWR Plot for 26.5 GHz Versions

Multiplexer Specification - 40 GHz Versions

Characteristic Impedance:	50 Ω
Connectors:	SMA-2.9
Bandwidth:	DC to 40 GHz
Maximum RF Carry Power:	60 W (0-3 GHz) 35 W (3-8 GHz) 30 W (8-12.4 GHz) 25 W (12.4-18 GHz) 15 W (18-26.5 GHz) 5 W (26.5-40 GHz)
Isolation:	>80 dB (0-3 GHz) >70 dB (3-8 GHz) >60 dB (8-12.4 GHz) >60 dB (12.4-18 GHz) >55 dB (18-26.5 GHz) >45 dB (26.5-40 GHz)
Insertion Loss:	<0.2 dB (0-3 GHz) <0.3 dB (3-8 GHz) <0.4 dB (8-12.4 GHz) <0.5 dB (12.4-18 GHz) <0.7 dB (18-26.5 GHz) <1.1 dB (26.5-40 GHz)
VSWR:	<1:1.2 (0-3 GHz) <1:1.3 (3-8 GHz) <1:1.4 (8-12.4 GHz) <1:1.5 (12.4-18 GHz) <1:1.7 (18-26.5 GHz) <1:2.2 (26.5-40 GHz)
Expected Life (low power):	>2 million operations per position guaranteed (typically >5 million)
Insertion Loss Repeatability:	Within 0.05 dB

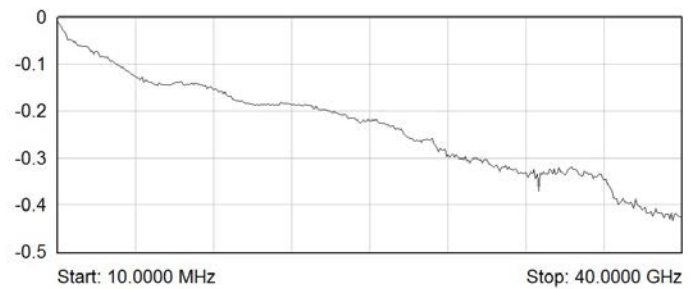

Typical Insertion Loss (dB) Plot for 40 GHz Versions

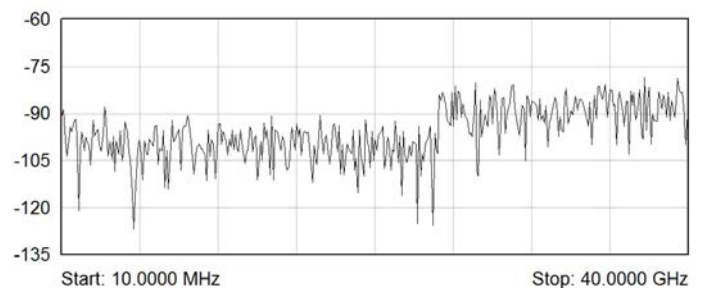

Typical Isolation (dB) Plot for 40 GHz Versions

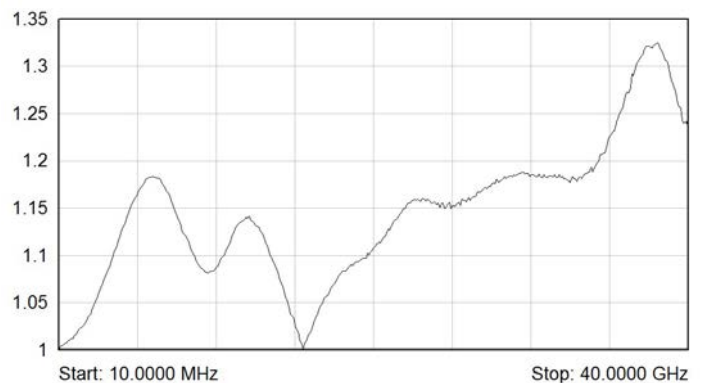

Typical VSWR Plot for 40 GHz Versions

Power Source

Universal AC mains supply, 90-120/200-240 V 50-60 Hz	
Power Inlet:	Male IEC connector
Power Rating:	100 VA maximum
Fuse Rating:	5 A, 250 V

LAN Interface

Compliant to LXI Standard 1.5, the 60-801 has a 1000Base-T Ethernet Interface via a standard RJ-45 connector mounted on the rear panel with an LCD display showing the unit's IP address.

LXI Status Indicators

Front panel mounted LEDs:

- Power
- Ready
- Error
- LAN
- Active

Mechanical Characteristics

Supplied with front panel ears to enable rack mounting on a shelf or other rear support mechanism.

Dimensions: Full 19" rack width, 500 mm depth

- 1-8 Bank Versions: 1U high.
- 9-16 Bank Versions: 2U high.

3D models for all versions in a variety of popular file formats are available on request.

Connectors

Signals via front panel SMA or SMA-2.9 connectors as version.

Cooling

Fan assisted cooling, side air intakes and rear exhaust.

Operating/Storage Conditions

Operating Temperature:	0 °C to +55 °C
Humidity:	Up to 90% non-condensing
Altitude:	5000 m
Storage/Transport Temperature:	-20 °C to +75 °C
Humidity:	Up to 90% non-condensing
Altitude:	15000 m

Safety & CE Compliance

All products are fully CE compliant and meet applicable EU directives:

Low-voltage safety EN61010-1:2010,
EMC Immunity EN61326-1:2013,
Emissions EN55011:2009+A1:2010.

Product Order Codes

LXI Microwave MUX, 50 Ω	
6 to 1 MUX, 6 GHz, SMA, 1U	60-801-00x
6 to 1 MUX, 6 GHz, SMA, 2U	60-801-0yy
6 to 1 MUX, 18 GHz, SMA, 1U	60-801-20x
6 to 1 MUX, 18 GHz, SMA, 2U	60-801-2yy
6 to 1 MUX, 26.5 GHz, SMA, 1U	60-801-30x
6 to 1 MUX, 26.5 GHz, SMA, 2U	60-801-3yy
6 to 1 MUX, 40 GHz, SMA-2.9, 1U	60-801-40x
6 to 1 MUX, 40 GHz, SMA-2.9, 2U	60-801-4yy

Where:

x = the number of 6 to 1 multiplexers between 1 & 8 banks.

yy = the number of 6 to 1 multiplexers between 9 & 16 banks.

Versions with other bank counts and different frequency ranges can be made to order, please contact sales office.

Product Customization

Pickering LXI units are designed and manufactured on our own flexible manufacturing lines, giving complete product control and enabling simple customization to meet very specific requirements.

Customization can include:

- Alternative relay types
- Mixture of relay types
- Alternative number of relays
- Different performance specifications

All customized products are given a unique part number, fully documented and may be ordered at any time in the future.

Please contact your local sales office to discuss.

Mating Connectors & Cabling

For connection accessories for the 60-801 please refer to the [90-011D](#) RF Cable Assemblies data sheet where a complete list and documentation can be found for accessories, or refer to our website.



The 60-801 Microwave MUX with 16 Multiplexer banks in 2U format

Connectivity Solutions

We provide a full range of supporting cable and connector solutions for all our switching products—20 connector families with 1200+ products. We offer everything from simple mating connectors to complex cables assemblies and terminal blocks. All assemblies are manufactured by Pickering and are guaranteed to mechanically and electrically mate to our modules. These accessories are detailed in Connector Accessories data sheets, where a complete list and documentation can be found for each accessory.



Connectors & Backshells



Multi-way Cable Assemblies

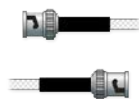

RF Cable Assemblies



Breakouts



Connector Blocks

We also offer customized cabling and have a free online **Cable Design Tool** that can be used to create custom cable solutions for many applications.

- Fully supported on modern browsers and tablet operating systems.
- Built-in tutorials and videos allow you to get quickly up to speed.
- Store cable assemblies in the Cloud and develop over time.
- Each cable design has a downloadable PDF documentation file detailing all specifications

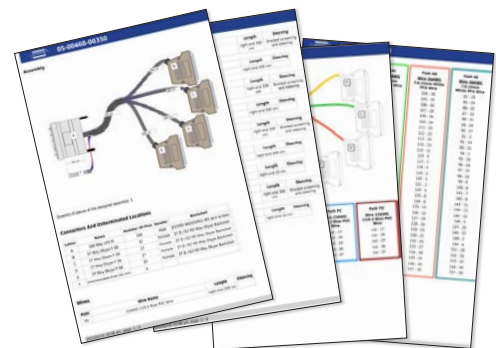

Start designing your custom cabling, go to pickeringtest.com/cdt

Mass Interconnect

We recommend the use of a mass interconnect solution when an Interchangeable Test Adapter (ITA) is required for PXI/LXI based test systems. Our modules are fully supported by Virginia Panel and MacPanel.

Pickering Reed Relays

We are the only switch provider with in-house reed relay manufacturing capability via our Relay Division. These instrument grade reed relays feature **SoftCenter™** technology, ensuring long service life and repeatable contact performance.

To learn more go to pickeringrelay.com

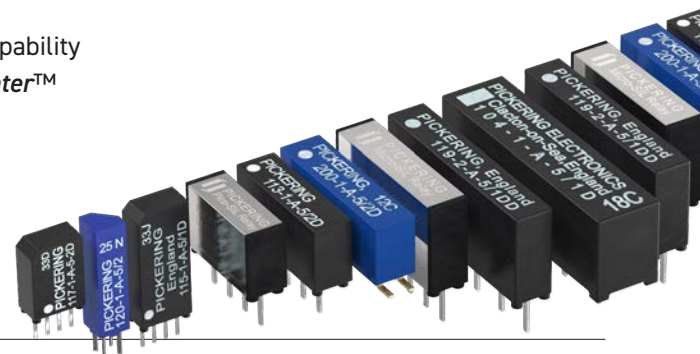

Programming

Pickering provide kernel, IVI and VISA (NI & Keysight) drivers which are compatible with all Microsoft supported versions of Windows and popular older versions.

For more information go to pickeringtest.com/os

The VISA driver support is provided for LabVIEW Real Time Operating Systems (Pharlap and Linux-RT). For other RTOS support contact Pickering. These drivers may be used with a variety of programming environments and applications including:

- Pickering Interfaces Switch Path Manager
- National Instruments products (LabVIEW, LabWindows/CVI, Switch Executive, MAX, TestStand, VeriStand, etc.)
- Microsoft Visual Studio products (Visual Basic, Visual C++)
- Programming Languages C, C++, C#, Python
- Keysight VEE and OpenTAP
- Mathworks MATLAB, Simulink
- Marvin ATEasy
- MTQ Testsolutions Tecap Test & Measurement Suite

Drivers for popular Linux distributions are available, other environments are also supported, please contact Pickering with specific enquiries. We provide Soft Front Panels (SFPs) for our products for familiarity and manual control, as well as comprehensive documentation and example programs to help you develop test routines with ease.

To learn more about software drivers and development environments go to pickeringtest.com/software

Signal Routing Software

Our signal routing software, Switch Path Manager, automatically selects and energizes switch paths through Pickering switching systems. Signal routing is performed by simply defining test system endpoints to be connected together, greatly accelerating Test System software development.

To learn more go to pickeringtest.com/spm

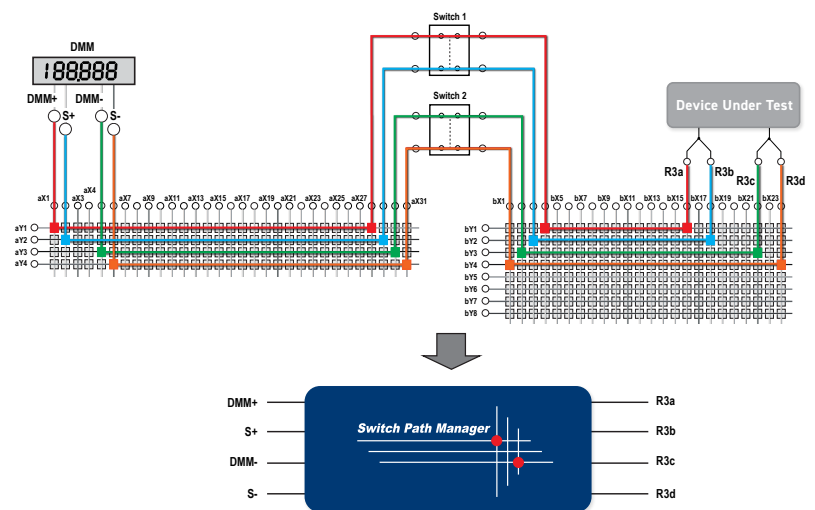

Diagnostic Relay Test Tools

eBIRST Switching System Test Tools are designed specifically for our PXI, PCI or LXI products, these tools simplify switching system fault-finding by quickly testing the system and graphically identifying the faulty relay.

To learn more go to pickeringtest.com/ebirst



Three Year Warranty & Guaranteed Long-Term Support

All standard products manufactured by Pickering Interfaces are warranted against defective materials and workmanship for three years from the date of delivery to the original purchaser. Extended warranty and service agreements are available with various levels for your requirements. Although we offer a 3-year warranty as standard, we also include guaranteed long-term support—with a history of supporting our products for typically 15-20 years.

To learn more go to pickeringtest.com/support

Available Product Resources

We have a library of resources including success stories, product and support videos, articles and white papers as well as application-specific brochures to assist you. We have also published reference books on switching technology and the PXI and LXI standards.

To view, download or request any of our product resources go to pickeringtest.com/resources

