

- Cable Assemblies
- Cable Connectors & Connector Blocks
- Breakouts & PCB Connectors
- Guaranteed Compatibility



Simple Connection

Pickering connection solutions provide a simple way of connecting to a user's device under test or remote connection. The products include cable assemblies, cable connectors, connector blocks, breakouts and pcb connectors.

Cable Assemblies

Cable assemblies are offered in connector to connector, and connector to unterminated versions. There are 3 termination options for the unterminated cables - ferrules, tinned copper or simple cut end.

Connector Blocks

Connector Blocks convert the 160-pin DIN41612 connections to an array of screw terminals. The customer can then interface to other devices using his own wiring. An alternative is a remote Breakout with screw terminals at the end of a cable assembly.

Custom Design Needs

Pickering Interfaces can manufacture custom connector accessories to suit any application. If you do not see what you need in this data sheet contact your Pickering Interfaces sales office with information on your requirements or consider using our free online Cable Design Tool.

Using our Cable Design Tool, you can graphically design your own custom cable assembly. Once completed and submitted, our engineers will generate a quote for your cable requirements. See pickeringtest.com/cdt



Examples of Pickering PXI and LXI Products using 160-Pin DIN41612 Connectors







Cable Assemblies

Description		End 1	End 2		Cable Length	Product Order Code and Part Number	Data Sheet Page
		Gender & Cable Exit	Gender & Cable Exit	Options			
	Cable Assy, 160-Pin DIN41612, 2 A	Male, Rear Cable Exit, 2 x M2.5 Female Screwlocks	Female, Rear Cable Exit, 1 x M2.5 Male Screwlock	-	0.5 m 1 m 2 m	40-970-160-0.5m-MF 40-970-160-1m-MF 40-970-160-2m-MF	6
		Female, Rear Cable Exit, 1 x M2.5 Male Screwlock	Female, Rear Cable Exit, 1 x M2.5 Male Screwlock	-	0.5 m 1 m 2 m	40-970A-160-0.5m-FF 40-970A-160-1m-FF 40-970A-160-2m-FF	7
		Female, 45° Cable Exit, 1 x M2.5 Male Screwlock	Female, 45° Cable Exit, 1 x M2.5 Male Screwlock	-	0.5 m 1 m 2 m	A1604F5-1604F5-0A050 A1604F5-1604F5-0A100 A1604F5-1604F5-0A200	8
		Female, 90° Cable Exit, 1 x M2.5 Male Screwlock	Female, 90° Cable Exit, 1 x M2.5 Male Screwlock	-	0.5 m 1 m 2 m	A1604FT-1604FT-0A050 A1604FT-1604FT-0A100 A1604FT-1604FT-0A200	9
	Cable Assy, 160-Pin DIN41612 to Unterminated, 2 A	Female, Rear Cable Exit, 1 x M2.5 Male Screwlock	NA	Ferrules	0.5 m 1 m 2 m	40-972A-160-0.5m-FU 40-972A-160-1m-FU 40-972A-160-2m-FU	10
Tinned End				0.5 m 1 m 2 m	A1604FR-T-0B050 A1604FR-T-0B100 A1604FR-T-0B200		
Cut End				0.5 m 1 m 2 m	A1604FR-C-0B050 A1604FR-C-0B100 A1604FR-C-0B200		
	Cable Assy, 160-Pin DIN41612 to Unterminated, 2 A	Female, 45° Cable Exit, 1 x M2.5 Male Screwlock	NA	Ferrules	0.5 m 1 m 2 m	A1604F5-F-0A050 A1604F5-F-0A100 A1604F5-F-0A200	11
Tinned End				0.5 m 1 m 2 m	A1604F5-T-0A050 A1604F5-T-0A100 A1604F5-T-0A200		
Cut End				0.5 m 1 m 2 m	A1604F5-C-0A050 A1604F5-C-0A100 A1604F5-C-0A200		
	Cable Assy, 160-Pin DIN41612 to Unterminated, 2 A	Female, 90° Cable Exit, 1 x M2.5 Male Screwlock	NA	Ferrules	0.5 m 1 m 2 m	A1604FT-F-0A050 A1604FT-F-0A100 A1604FT-F-0A200	12
Tinned End				0.5 m 1 m 2 m	A1604FT-T-0A050 A1604FT-T-0A100 A1604FT-T-0A200		
Cut End				0.5 m 1 m 2 m	A1604FT-C-0A050 A1604FT-C-0A100 A1604FT-C-0A200		

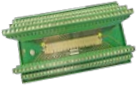

Note: Custom lengths by quotation

Please click on the page number to navigate to the data sheet page required. Return to this page via the  button.

Female Connector Blocks/Connectors

Description		Gender & Cable Exit	Type	Product Order Code and Part Number	Page
	Connector Block, 160-Pin DIN41612, 2 A, Screw Terminal	Female, Rear, 1 x M2.5 Male Screwlock	With Backshell	40-965-160-F	13
			Without Backshell	92-965-160-F	
	Breakout with DIN Rail Mount, 160-Pin DIN41612, 2 A, Screw Terminal	Female, 2 x M2.5 Male Screwlocks	DIN Rail Mount	40-967-160-F	14
	Cable Connector 160-Pin DIN41612, 2 A, Crimp-Pin	Female, Rear Cable Exit, 1 x M2.5 Male Screwlock	With Backshell	40-960A-160-F	16
			Without Backshell	92-960-160-F	
	Cable Connector 160-Pin DIN41612, 2 A, Crimp-Pin	Female, 45° Cable Exit, 1 x M2.5 Male Screwlock	With Backshell	40-960-160-F5	18
			Female, 90° Cable Exit, 1 x M2.5 Male Screwlock	With Backshell	40-960-160-FT
	PCB Connector 160-Pin DIN41612, 2 A. (Unmodified)	Female	Right Angle PCB Mount	40-963-160-RF	22
	PCB Connector 160-Pin DIN41612, 2 A. (Modified)		Straight PCB Mount	C1604FX-4PS-0A	24

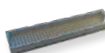

Male Breakouts/PCB Connectors

Description		Gender & Cable Exit	Type	Product Order Code and Part Number	Page
	Breakout with DIN Rail Mount, 160-Pin DIN41612, 2 A, Screw Terminal	Male, 2 x M2.5 Female Screwlocks	DIN Rail Mount	40-967-160-M	26
	PCB Connector 160-Pin DIN41612, 2 A. (Unmodified)	Male	Right Angle PCB Mount	40-963-160-RM	28
	PCB Connector 160-Pin DIN41612, 2 A. (Modified)		Straight PCB Mount	40-963-160-SM	30

Additional Accessories





Although the items below do not directly mate with Pickering Interfaces products, customers may find them useful in the development of their own connection solutions.

Cable Assemblies





Description		End 1	End 2		Cable Length	Product Order Code and Part Number	Data Sheet Page
		Gender & Cable Exit	Gender & Cable Exit	Options			
	Cable Assy, 160-Pin DIN41612, 2A	Male, Rear Cable Exit, 2 x M2.5 Female Screwlocks	Male, Rear Cable Exit, 2 x M2.5 Female Screwlocks	-	0.5 m 1 m 2 m	40-970-160-0.5m-MM 40-970-160-1m-MM 40-970-160-2m-MM	33
	Cable Assy, 160-Pin DIN41612 to Unterminated, 2A	Male, Rear Cable Exit, 2 x M2.5 Female Screwlocks	NA	Ferrules	0.5 m 1 m 2 m	40-972-160-0.5m-MU 40-972-160-1m-MU 40-972-160-2m-MU	34
				Tinned End	0.5 m 1 m 2 m	A1604MR-T-0A050 A1604MR-T-0A100 A1604MR-T-0A200	
				Cut End	0.5 m 1 m 2 m	A1604MR-C-0A050 A1604MR-C-0A100 A1604MR-C-0A200	

Note: Custom lengths by quotation

Connector Blocks/Connectors

Description		Gender & Cable Exit	Type	Product Order Code and Part Number	Page
	Connector Block, 160-Pin DIN41612, 2A, Screw Termina	Male, Rear Cable Exit, 1 x M2.5 Female Screwlock	With Backshell	B1604MR-4F-0A	35
			Without Backshell	92-965-160-M	
	Cable Connector 160-Pin DIN41612, 2A, Solder Pin	Male, Rear Cable Exit, 2 x M2.5 Female Screwlocks	With Backshell	40-960-160-M	36
			Without Backshell	92-960-160-M	
	PCB Connector 160-Pin DIN41612, 2A. (Unmodified)	Female	Straight PCB Mount	40-963-160-SF	37
	PCB Connector 160-Pin DIN41612, 2A. (Unmodified)	Male	Straight PCB Mount	C1604MX-XPS-0A	39

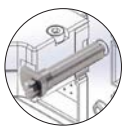
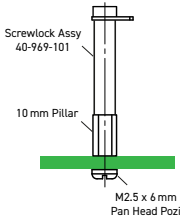
Tools/Other Items

	Description	Product Order Code and Part Number	Page
	Crimp Tool, DIN41612	40-964-160-C	16
	Extractor Tool, DIN41612	40-964-160-E	
	Screwlock Assembly, 160-Pin, 4.5 mm AF	40-969-101	6
	Screwlock Assembly Kit. Comprises 2 x Screwlock Assy 40-969-101, 2 x 10 mm Brass Pillars, and 2 x M2.5 x 6 mm Pan Head Pozi Screws	40-969-102	30
	3U PXI Front Panel Kit	44-960-160-FP	6
	160-Pin DIN41612 Crimp Pin Pack of 80 Female Contacts	40-960A-160-FCP	16

Appendix

Details of recent product part number changes.....	41
--	----

Custom Termination

Customization Possibilities.....	43
----------------------------------	----

- High Specification, Highly Flexible Cable
- Fully Screened Cable Construction with Strain Relief
- An Alternative PXI Front Panel 44-960-160-FP is Available for PXI Products Requiring a Second Fixing
- Optional Screwlock Assembly 40-969-101 provides a Second LXI Fixing where Necessary - See Diagram

Technical Specification

Connector Type (End A):	160-Pin DIN41612
Gender	Female
Securing Method	1 x M2.5 screwlock, male (centrally positioned)
Connector Type (End B):	160-Pin DIN41612
Gender	Male
Securing Method	2 x M2.5 screwlocks, female (centrally positioned)
Maximum Current	2 A
Maximum Voltage	500 V DC or AC peak
Insulation Resistance	1000 MOhm
Connectors:	
Contact Material	Gold plated copper alloy
Contact Resistance	<20 mOhm
Cable Exit	Rear
Overall Size (Approx)	H99 x W18 x D61 mm
Cable Type:	Individual wires, screened & sleeved
Conductor: Material	Silver plated copper wire
Strands	7/0.15 (0.124 mm ² , 26AWG)
Resistance	0.137 Ω/m
Insulation	PFA
Outer Sleeve	Polyester
Screened Construction	Yes (Cable screen connected to backshells)
Additional Braided Sleeve	Yes
Cable O/D	15 mm
Minimum Bend Radius	25 mm
Door Closure Allowance	105 mm (see diagram)

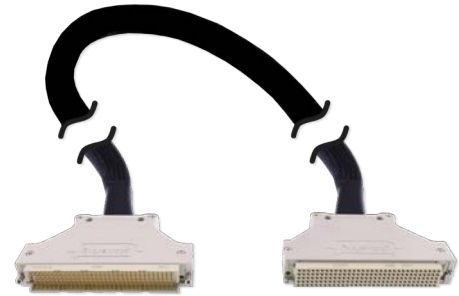

160-Pin DIN41612 Cable Assy - Male to Female

Product Compatibility

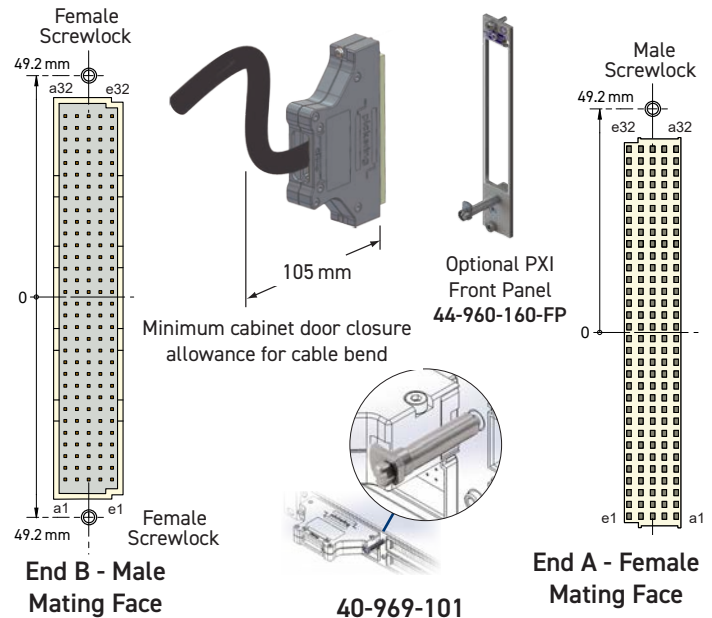
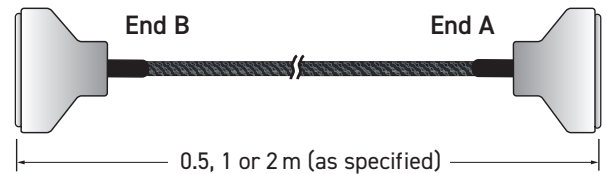
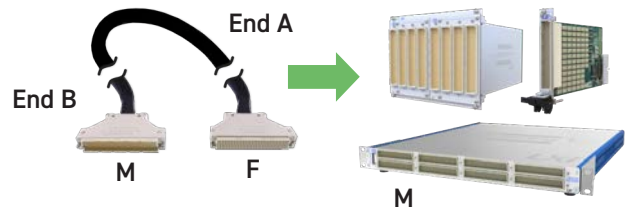

Characteristic Plots for A1604MR-1604FR-5A050

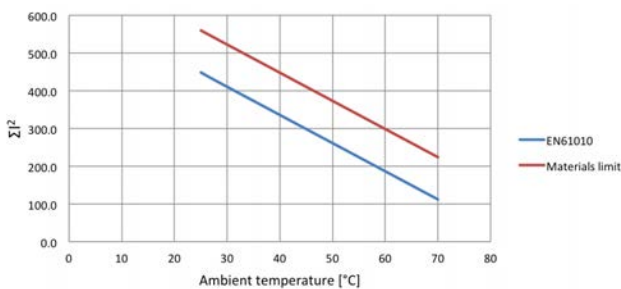

The graph shows the permitted ΣI^2 versus ambient temperature in accordance with EN61010 for user exposure to surface temperature and a higher limit imposed by the materials used where the cable is not directly user accessible.

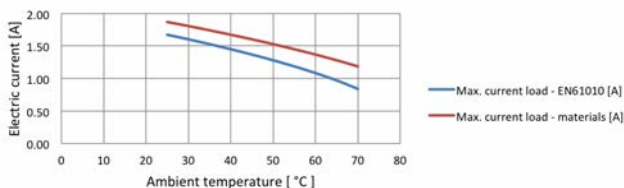

The graph shows the allowed current versus temperature assuming ALL wires carry the same current. Higher currents to the cable rating are permitted on individual wires provided the ΣI^2 is complied with.

Product Order Codes

160-Pin DIN41612 Cable Assy, 2 A, Male to Female, 0.5 m Long	40-970-160-0.5m-MF
1.0 m Long	40-970-160-1m-MF
2.0 m Long	40-970-160-2m-MF

Screwlock Assy 160-Pin, 4.5 mm AF	40-969-101
PXI Front Panel Kit	44-960-160-FP

Note: Other cable lengths can be supplied.

- High Specification, Highly Flexible Cable
- Fully Screened Cable Construction with Strain Relief
- An Alternative PXI Front Panel 44-960-160-FP is Available for PXI Products Requiring a Second Fixing
- Optional Screwlock Assembly 40-969-101 provides a Second LXI Fixing where Necessary - See Diagram

Technical Specification

Connector Type (End A):	160-Pin DIN41612
Gender	Female
Securing Method	1 x M2.5 screwlock, male (centrally positioned)
Connector Type (End B):	160-Pin DIN41612
Gender	Female
Securing Method	1 x M2.5 screwlock, male (centrally positioned)
Maximum Current	2 A
Maximum Voltage	500 V DC or AC peak
Insulation Resistance	1000 MOhm
Connectors:	
Contact Material	Gold plated copper alloy
Contact Resistance	<20 mOhm
Cable Exit	Rear
Overall Size (Approx)	H99 x W18 x D60 mm
Cable Type:	Individual wires, screened & sleeved
Conductor: Material	Silver plated copper wire
Strands	7/0.15 (0.124 mm ² , 26AWG)
Resistance	0.137 Ω/m
Insulation	PFA
Outer Sleeve	Polyester
Screened Construction	Yes (Cable screen connected to backshells)
Additional Braided Sleeve	Yes
Cable O/D	15 mm
Minimum Bend Radius	25 mm
Door Closure Allowance	105 mm (see diagram)

Characteristic Plots for 40-970-160-0.5m

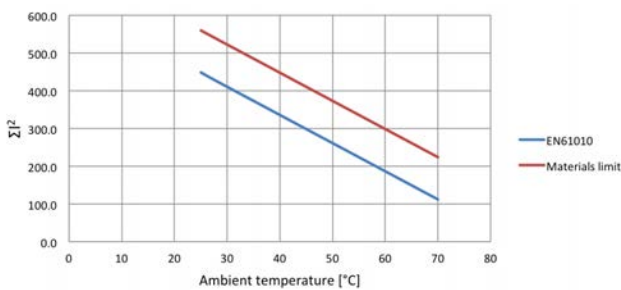

The graph shows the permitted ΣI^2 versus ambient temperature in accordance with EN61010 for user exposure to surface temperature and a higher limit imposed by the materials used where the cable is not directly user accessible.

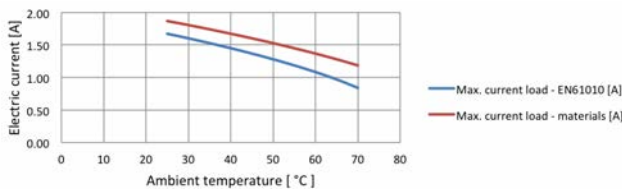

The graph shows the allowed current versus temperature assuming ALL wires carry the same current. Higher currents to the cable rating are permitted on individual wires provided the ΣI^2 is complied with.

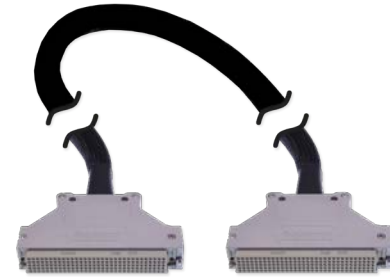

160-Pin DIN41612 Cable Assy - Female to Female

Product Compatibility

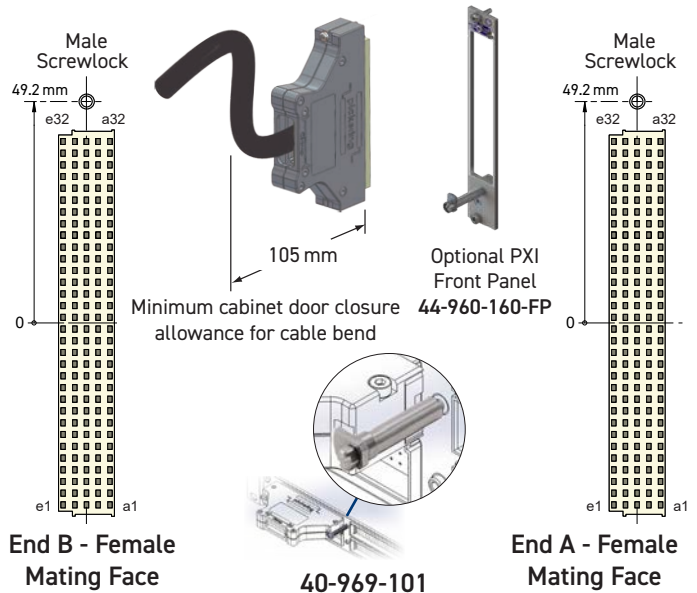
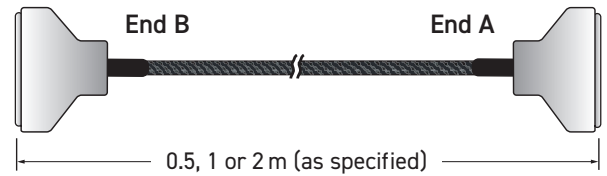
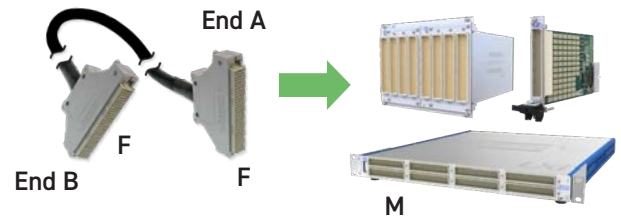

Product Order Codes

160-Pin DIN41612 Cable Assy, 2 A, Female to Female, 0.5 m Long	40-970A-160-0.5m-FF
1.0 m Long	40-970A-160-1m-FF
2.0 m Long	40-970A-160-2m-FF
Screwlock Assy 160-Pin, 4.5 mm AF	40-969-101
PXI Front Panel Kit	44-960-160-FP

Note: Other cable lengths can be supplied.

- High Specification, Highly Flexible Cable with 45° Exit
- Fully Screened Cable Construction with Strain Relief
- An Alternative PXI Front Panel 44-960-160-FP is Available for PXI Products Requiring a Second Fixing
- Optional Screwlock Assembly 40-969-101 provides a Second LXI Fixing where Necessary - See Diagram

Technical Specification

Connector Type (End A):	160-Pin DIN41612
Gender	Female
Securing Method	1 x M2.5 screwlock, male (centrally positioned)
Connector Type (End B):	160-Pin DIN41612
Gender	Female
Securing Method	1 x M2.5 screwlock, male (centrally positioned)
Maximum Current	2 A
Maximum Voltage	500 V DC or AC peak
Insulation Resistance	1000 MOhm
Connectors:	
Contact Material	Gold plated copper alloy
Contact Resistance	<20 mOhm
Cable Exit	45° (Towards pins a1-e1)
Overall Size (Approx)	H99 x W18 x D87 mm
Cable Type:	Individual wires, screened & sleeved
Conductor: Material	Silver plated copper wire
Strands	7/0.15 (0.124 mm ² , 26AWG)
Resistance	0.137 Ω/m
Insulation	PFA
Outer Sleeve	Polyester
Screened Construction	Yes (Cable screen connected to backshells)
Additional Braided Sleeve	Yes
Cable O/D	15 mm
Minimum Bend Radius	25 mm
Door Closure Allowance	82 mm (see diagram)



160-Pin DIN41612 Cable Assy - Female to Female

Product Compatibility

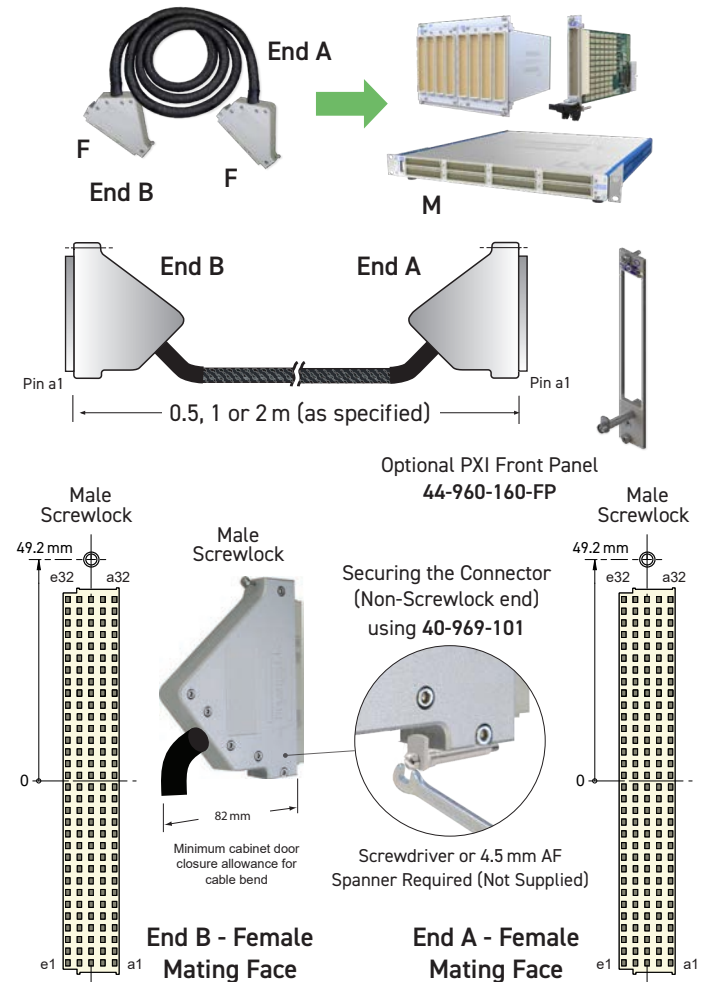

Characteristic Plots for A1604F5-1604F5-0A050

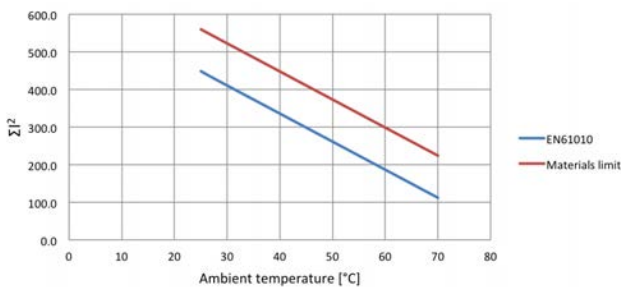

The graph shows the permitted ΣI^2 versus ambient temperature in accordance with EN61010 for user exposure to surface temperature and a higher limit imposed by the materials used where the cable is not directly user accessible.

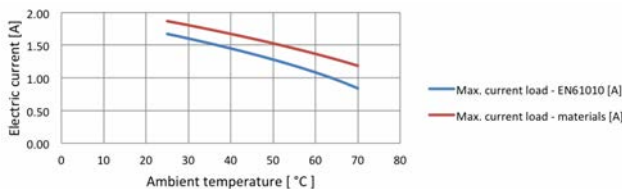

The graph shows the allowed current versus temperature assuming ALL wires carry the same current. Higher currents to the cable rating are permitted on individual wires provided the ΣI^2 is complied with.

Product Order Codes

160-Pin DIN41612 Cable Assy, Cable Exit 45° (Towards Pins a1-e1), 2 A,	
Female to Female, 0.5 m Long	A1604F5-1604F5-0A050
Female to Female, 1.0 m Long	A1604F5-1604F5-0A100
Female to Female, 2.0 m Long	A1604F5-1604F5-0A200

Screwlock Assy 160-Pin, 4.5 mm AF	40-969-101
PXI Front Panel Kit	44-960-160-FP

Note: Other cable lengths can be supplied.

- High Specification, Highly Flexible Cable with 90° Exit
- Fully Screened Cable Construction with Strain Relief
- An Alternative PXI Front Panel 44-960-160-FP is Available for PXI Products Requiring a Second Fixing
- Optional Screwlock Assembly 40-969-101 provides a Second LXI Fixing where Necessary - See Diagram

Technical Specification

Connector Type (End A):	160-Pin DIN41612
Gender	Female
Securing Method	1 x M2.5 screwlock, male (centrally positioned)
Connector Type (End B):	160-Pin DIN41612
Gender	Female
Securing Method	1 x M2.5 screwlock, male (centrally positioned)
Maximum Current	2 A
Maximum Voltage	500 V DC or AC peak
Insulation Resistance	1000 MOhm
Connectors:	
Contact Material	Gold plated copper alloy
Contact Resistance	<20 mOhm
Cable Exit	90° (Towards pins a1-e1)
Overall Size (Approx)	H99 x W18 x D67 mm
Cable Type:	Individual wires, screened & sleeved
Conductor: Material	Silver plated copper wire
Strands	7/0.15 (0.124 mm ² , 26AWG)
Resistance	0.137 Ω/m
Insulation	PFA
Outer Sleeve	Polyester
Screened Construction	Yes (Cable screen connected to backshells)
Additional Braided Sleeve	Yes
Cable O/D	15 mm
Minimum Bend Radius	25 mm
Door Closure Allowance	67 mm (see diagram)



160-Pin DIN41612 Cable Assy - Female to Female

Product Compatibility

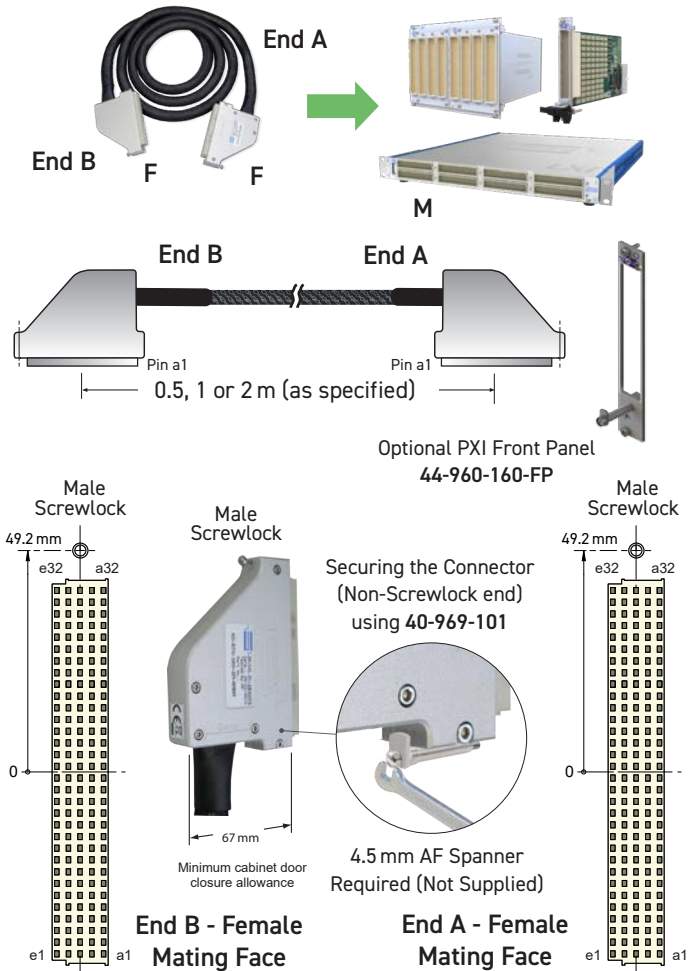

Characteristic Plots for A1604FT-1604FT-0A050

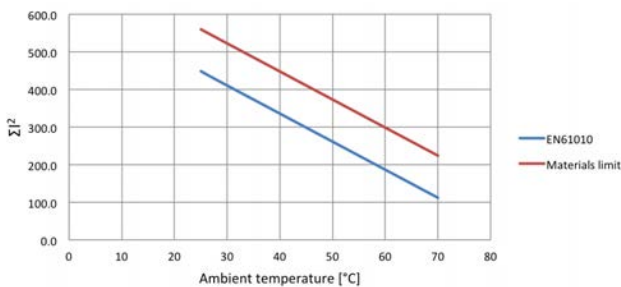

The graph shows the permitted ΣI^2 versus ambient temperature in accordance with EN61010 for user exposure to surface temperature and a higher limit imposed by the materials used where the cable is not directly user accessible.

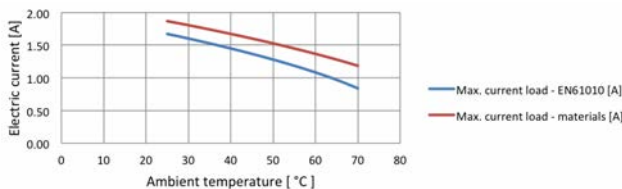

The graph shows the allowed current versus temperature assuming ALL wires carry the same current. Higher currents to the cable rating are permitted on individual wires provided the ΣI^2 is complied with.

Product Order Codes

160-Pin DIN41612 Cable Assy, Cable Exit 90° (Towards Pins a1-e1), 2 A,	
Female to Female, 0.5 m Long	A1604FT-1604FT-0A050
Female to Female, 1.0 m Long	A1604FT-1604FT-0A100
Female to Female, 2.0 m Long	A1604FT-1604FT-0A200

Screwlock Assy 160-Pin, 4.5 mm AF	40-969-101
PXI Front Panel Kit	44-960-160-FP

Note: Other cable lengths can be supplied.

- High Specification, Highly Flexible Cable
- Fully Coded Markers to Ensure Easy Connection
- An Alternative PXI Front Panel 44-960-160-FP is Available for PXI Products Requiring a Second Fixing
- Optional Screwlock Assembly 40-969-101 provides a Second LXI Fixing where Necessary - See Diagram

Technical Specification

Connector Type (End A):	160-Pin DIN41612
Gender:	Female
Securing Method:	1 x M2.5 screwlock, male (centrally positioned)
Unterminated End (End B):	
Wire End Options:	Ferrules, Tinned, Cut End
Free Wire Length:	130 mm nominal
Individual Wire Labelling:	To connector pins A white/black screen pigtail is also included
Maximum Current:	2 A
Maximum Voltage:	500 V DC or AC peak
Insulation Resistance:	1000 MOhm
Connector:	
Contact Material:	Gold plated copper alloy
Contact Resistance:	<20 mOhm
Cable Exit:	Rear
Overall Size (Approx):	H99 x W18 x D60 mm
Cable Type:	Individual wires, screened & sleeved
Conductor: Material:	Silver plated copper wire
Strands:	7/0.15 (0.124 mm ² , 26AWG)
Resistance:	0.137 Ω/m
Insulation:	PFA
Outer Sleeve:	Polyester
Screened Construction:	Yes (Cable screen connected to backshell)
Additional Braided Sleeve:	Yes
Cable O/D:	15 mm
Minimum Bend Radius:	25 mm
Door Closure Allowance:	105 mm (see diagram)

Characteristic Plots for 40-972-160-0.5m

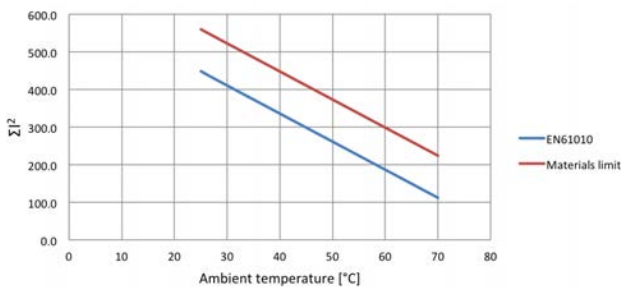

The graph shows the permitted ΣI^2 versus ambient temperature in accordance with EN61010 for user exposure to surface temperature and a higher limit imposed by the materials used where the cable is not directly user accessible.

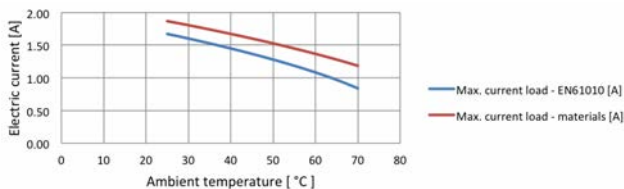

The graph shows the allowed current versus temperature assuming ALL wires carry the same current. Higher currents to the cable rating are permitted on individual wires provided the ΣI^2 is complied with.



160-Pin DIN41612 Cable Assy - Female to Unterminated

Product Compatibility

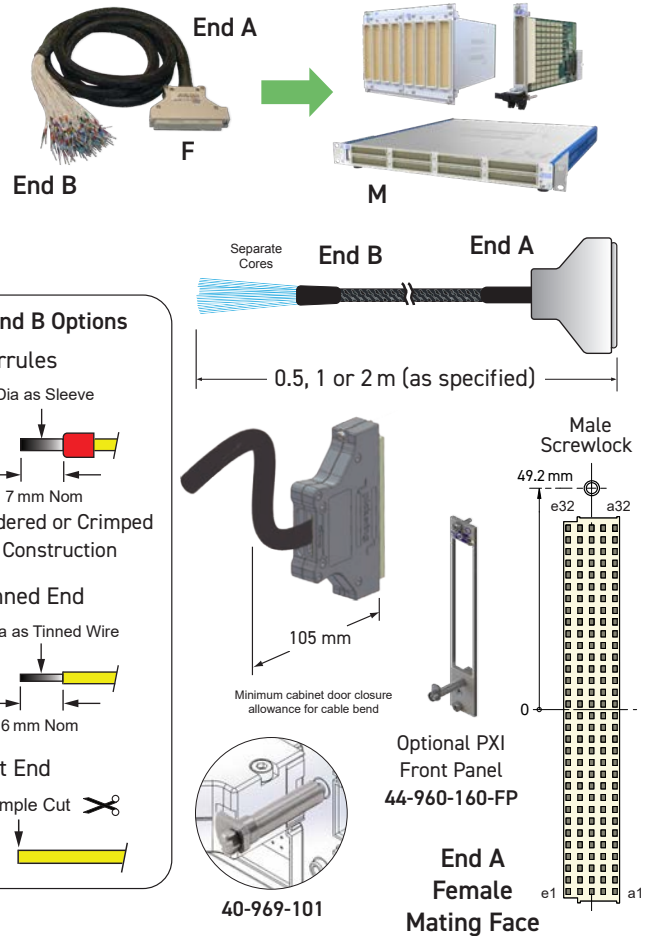

Product Order Codes

- 160-Pin DIN41612 Cable Assy, 2 A, Boot Lace Ferrules, Female to Unterminated, 0.5 m Long [40-972A-160-0.5m-FU](#)
- Female to Unterminated, 1.0 m Long [40-972A-160-1m-FU](#)
- Female to Unterminated, 2.0 m Long [40-972A-160-2m-FU](#)

Part numbers for other versions:

End B: T = Tinned End C = Cut End	A1604FR-*-0B***	Cable Length: 050 = 0.5 m 100 = 1.0 m 200 = 2.0 m
---	------------------------	--

Screwlock Assy 160-Pin, 4.5 mm AF [40-969-101](#)

PXI Front Panel Kit [44-960-160-FP](#)

Note: Other cable lengths can be supplied.

- High Specification, Highly Flexible Cable with 45° Exit
- An Alternative PXI Front Panel 44-960-160-FP is Available for PXI Products Requiring a Second Fixing
- Optional Screwlock Assembly 40-969-101 provides a Second LXI Fixing where Necessary - See Diagram

Technical Specification

Connector Type (End A):	160-Pin DIN41612
Gender	Female
Securing Method	1 x M2.5 screwlock, male (centrally positioned)
Unterminated End (End B):	
Wire End Options	Ferrules, Tinned, Cut End
Free Wire Length	130 mm nominal
Individual Wire Labelling	To connector pins A white/black screen pigtail is also included
Maximum Current	2 A
Maximum Voltage	500 V DC or AC peak
Insulation Resistance	1000 MOhm
Connector:	
Contact Material	Gold plated copper alloy
Contact Resistance	<20 mOhm
Cable Exit	45° (Towards pins a1-e1)
Overall Size (Approx)	H99 x W18 x D87 mm
Cable Type:	Individual wires, screened & sleeved
Conductor: Material	Silver plated copper wire
Strands	7/0.15 (0.124 mm ² , 26AWG)
Resistance	0.137 Ω/m
Insulation	PFA
Outer Sleeve	Polyester
Screened Construction	Yes (Cable screen connected to backshell)
Additional Braided Sleeve	Yes
Cable O/D	15 mm
Minimum Bend Radius	25 mm
Door Closure Allowance	82 mm (see diagram)

Characteristic Plots for A1604F5-*-0A050

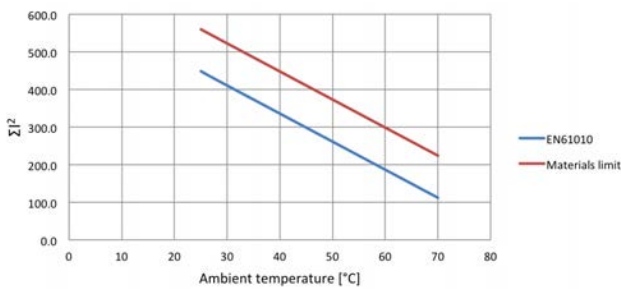

The graph shows the permitted ΣI^2 versus ambient temperature in accordance with EN61010 for user exposure to surface temperature and a higher limit imposed by the materials used where the cable is not directly user accessible.

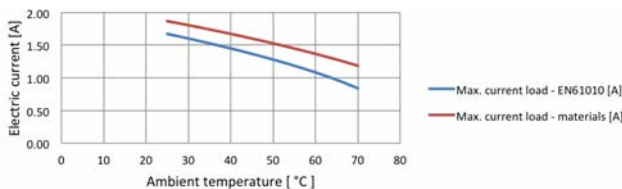

The graph shows the allowed current versus temperature assuming ALL wires carry the same current. Higher currents to the cable rating are permitted on individual wires provided the ΣI^2 is complied with.



160-Pin DIN41612 Cable Assy - Female to Unterminated

Product Compatibility

End B Options

- Ferrules**
Dia as Sleeve
7 mm Nom
Soldered or Crimped Construction
- Tinned End**
Dia as Tinned Wire
6 mm Nom
- Cut End**
Simple Cut

End A Female Mating Face

- Separate Cores
- 0.5, 1 or 2 m (as specified)
- Pin a1
- Male Screwlock
- Optional PXI Front Panel 44-960-160-FP
- 49.2mm
- e32, a32, e1, a1
- 82mm
- Minimum cabinet door closure allowance for cable bend

Securing the Connector (Non-Screwlock end) using 40-969-101
Screwdriver or 4.5 mm AF Spanner Required (Not Supplied)

Product Order Codes

160-Pin DIN41612 Cable Assy, Cable Exit 45° (Towards Pins a1-e1), 2 A, with End and Length Options

A1604F5-*-0A***	
End B: F = Ferrules T = Tinned End C = Cut End	Cable Length: 050 = 0.5 m 100 = 1.0 m 200 = 2.0 m

Screwlock Assy 160-Pin, 4.5 mm AF **40-969-101**
 PXI Front Panel Kit **44-960-160-FP**

Note: Other cable lengths can be supplied.

- High Specification, Highly Flexible Cable with 90° Exit
- Fully Coded Markers to Ensure Easy Connection
- An Alternative PXI Front Panel 44-960-160-FP is Available for PXI Products Requiring a Second Fixing
- Optional Screwlock Assembly 40-969-101 provides a Second LXI Fixing where Necessary - See Diagram

Technical Specification

Connector Type (End A):	160-Pin DIN41612
Gender:	Female
Securing Method:	1 x M2.5 screwlock, male (centrally positioned)
Unterminated End (End B):	
Wire End Options:	Ferrules, Tinned, Cut End
Free Wire Length:	130 mm nominal
Individual Wire Labelling:	To connector pins A white/black screen pigtail is also included
Maximum Current:	2 A
Maximum Voltage:	500 V DC or AC peak
Insulation Resistance:	1000 MOhm
Connector:	
Contact Material:	Gold plated copper alloy
Contact Resistance:	<20 mOhm
Cable Exit:	90° (Towards pins a1-e1)
Overall Size (Approx):	H99 x W18 x D67 mm
Cable Type:	Individual wires, screened & sleeved
Conductor: Material:	Silver plated copper wire
Strands:	7/0.15 (0.124 mm ² , 26AWG)
Resistance:	0.137 Ω/m
Insulation:	PFA
Outer Sleeve:	Polyester
Screened Construction:	Yes (Cable screen connected to backshell)
Additional Braided Sleeve:	Yes
Cable O/D:	15 mm
Minimum Bend Radius:	25 mm
Door Closure Allowance:	67 mm (see diagram)

Characteristic Plots for A1604FT-*-0A050

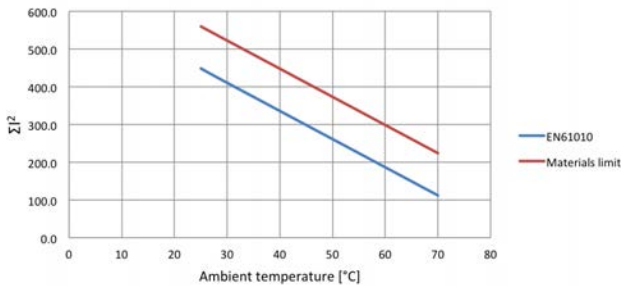

The graph shows the permitted ΣI^2 versus ambient temperature in accordance with EN61010 for user exposure to surface temperature and a higher limit imposed by the materials used where the cable is not directly user accessible.

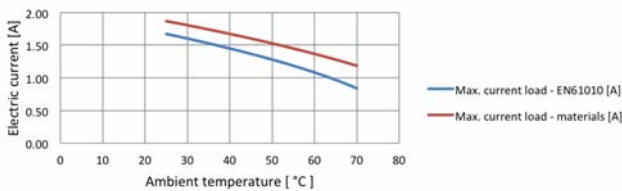

The graph shows the allowed current versus temperature assuming ALL wires carry the same current. Higher currents to the cable rating are permitted on individual wires provided the ΣI^2 is complied with.



160-Pin DIN41612 Cable Assy - Female to Unterminated

Product Compatibility

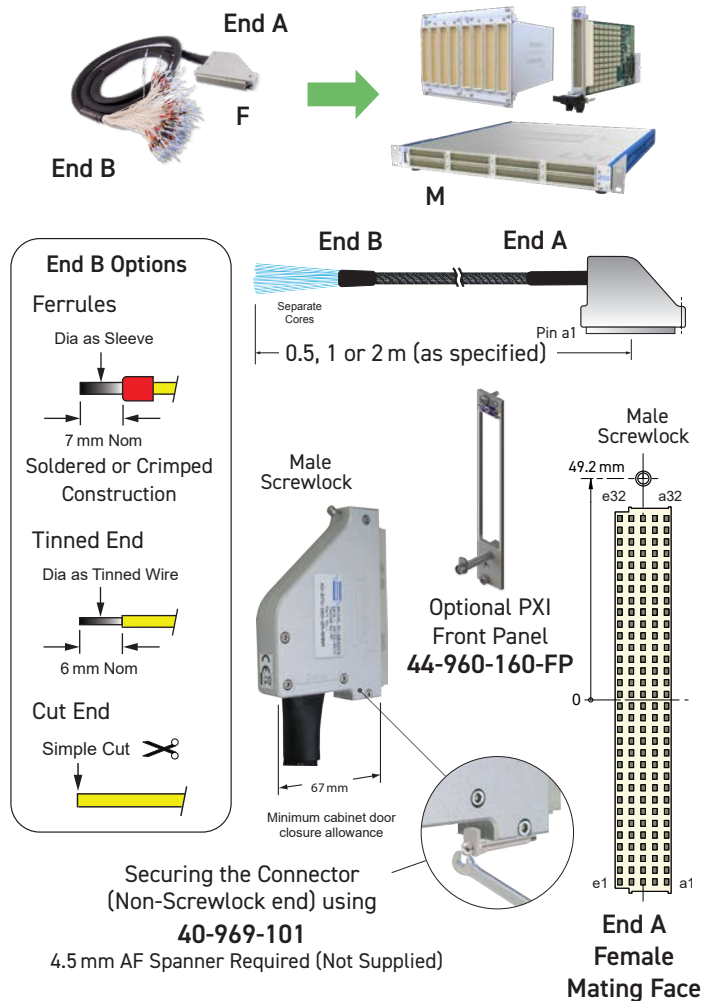

Product Order Codes

160-Pin DIN41612 Cable Assy, Cable Exit 90° (Towards Pins a1-e1), 2 A, with End and Length Options.

End B: F = Ferrules T = Tinned End C = Cut End	A1604FT-*-0A***	Cable Length: 050 = 0.5 m 100 = 1.0 m 200 = 2.0 m
--	------------------------	---

Screwlock Assy 160-Pin, 4.5 mm AF **40-969-101**
 PXI Front Panel Kit **44-960-160-FP**

Note: Other cable lengths can be supplied.

- Connector and PCB Only or Connector, PCB & Backshell
- Male Screwlock
- Cable Clamp in Backshell
- Easy to Use Rising Cage Screw Terminals

Connector blocks provide a convenient method of termination without the use of custom cabling. However, a higher resistance path, lower capacity ratings and lower voltage ratings are typical.

Suitable for use on the front of PXI modules this connector block provides a simple method of connecting to high density DIN41612 connectors. The screw terminals use a rising cage clamp mechanism to minimize risk of copper strand breakage. PTFE/PFA cables are recommended for use with this connector block to maximise copper cross-sectional area and insulation properties. Connector blocks will have higher losses than a cable connection and the breakdown voltage is controlled by clearances to the metal shell. The metal shell includes an internal insulation barrier under the carrier board.

Technical Specification

Connector Type:	160-Pin DIN41612
Gender	Female
Securing Method:	
Product with Backshell	1 x M2.5 screwlock, male (Centrally positioned)
Product without Backshell	Screwlocks not provided
Wire Connection	Rising cage screw terminals
Cable Screen Connection	Solder ring terminal
Connector Block Ratings:	
Maximum Current	2 A
Maximum Voltage	200 V DC or AC peak
Cable Exit	Dual rear - 11 x 24 mm
Overall Size (Approx)	H99 x W19 x D143 mm
160-Pin DIN41612:	
Contact Material	Gold plated copper alloy
Contact Resistance	<20 mOhm
Screw Terminals:	
Maximum Wire Size	20AWG
Recommended Insulation	PTFE/PFA
Additional Cable Clamp	Yes (in backshell)

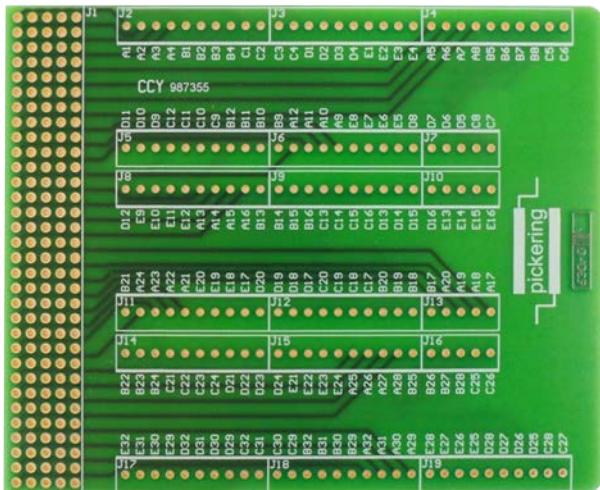

PCB Legend

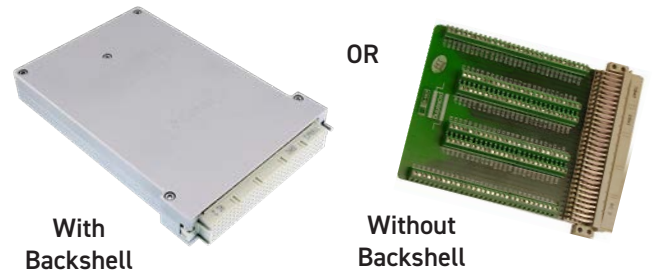

160-Pin DIN41612 Connector Block

Product Compatibility

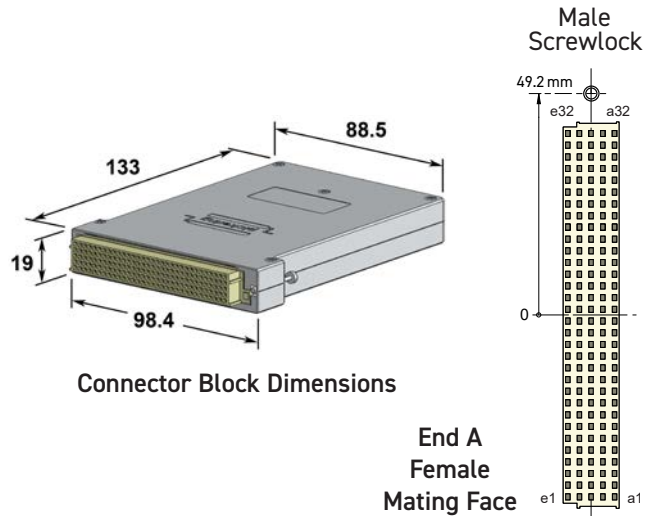
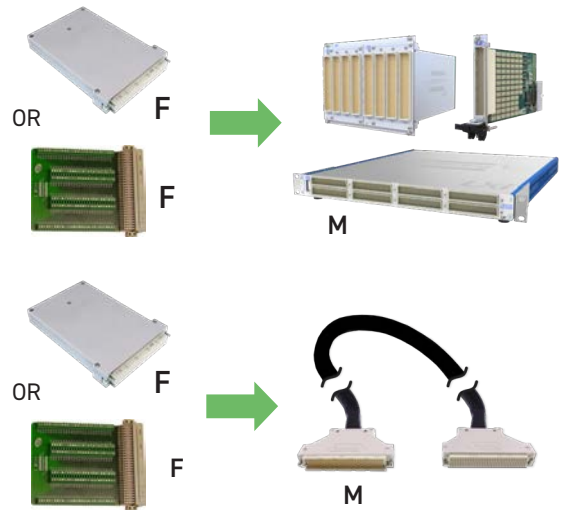

Connector Block Dimensions

Note: When the product is used without a backshell appropriate safety precautions should be observed.

Product Order Codes

160-Pin DIN41612 Connector Block, 2 A, Screw Terminal, With Backshell, Female	40-965-160-F
Without Backshell, Female	92-965-160-F

- For Connection at Cable End
- Simple to Use Rising Cage Screw Clamp Termination
- DIN Rail Mounted

Connector blocks provide a convenient method of termination without the use of custom cabling. However, a higher resistance path, lower capacity ratings and lower voltage ratings are typical.

This termination option is capable of accepting heavy duty connection wires and uses rising clamp screw terminals to minimize the danger of copper strand damage. Users should care take to protect the termination and provide a suitable method of restraining the cables.

When using this product please ensure appropriate electrical safety precautions are observed.

Technical Specification

Breakout Type:	160-Pin DIN41612
Gender	Female
Securing Method:	2 x M2.5 screwlocks, male (Centrally positioned)
Wire Connection	Rising cage screw terminals A screen connection is provided
Breakout Ratings:	
Maximum Current	2 A
Maximum Voltage	500 V DC or AC peak
Securing Method	Suitable for securing to DIN rails
Overall Size (Approx)	H181 x W112 x D69 mm
160-Pin DIN41612:	
Contact Material	Gold plated copper alloy
Contact Resistance	<20 mOhm
Screw Terminals:	
Maximum Wire Size	12AWG
Additional Cable Clamp	No

Note: Dimensional and PCB layout drawings can be found on the following page.

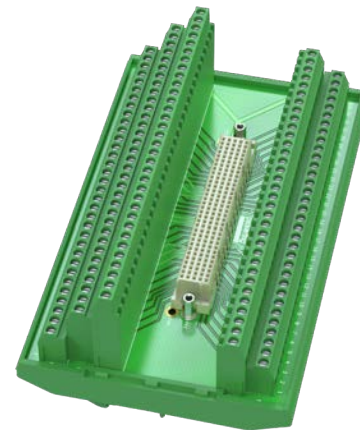

160-Pin DIN41612 Breakout

Product Compatibility

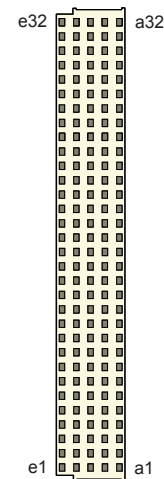
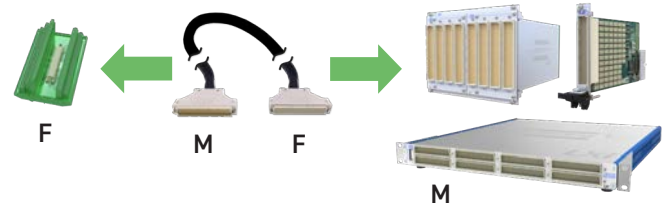

End A
Female
Mating Face

Product Order Codes

160-Pin DIN41612 Breakout with DIN Rail Mount, 2 A,
Screw Terminal, Female **40-967-160-F**

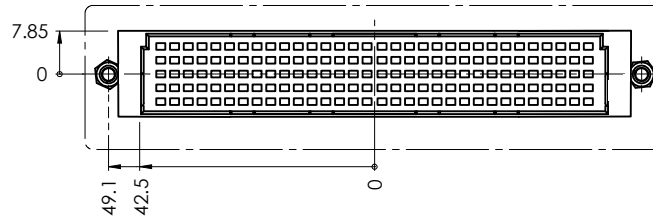

Detail: 160-Pin Connector - Screwlock Positions

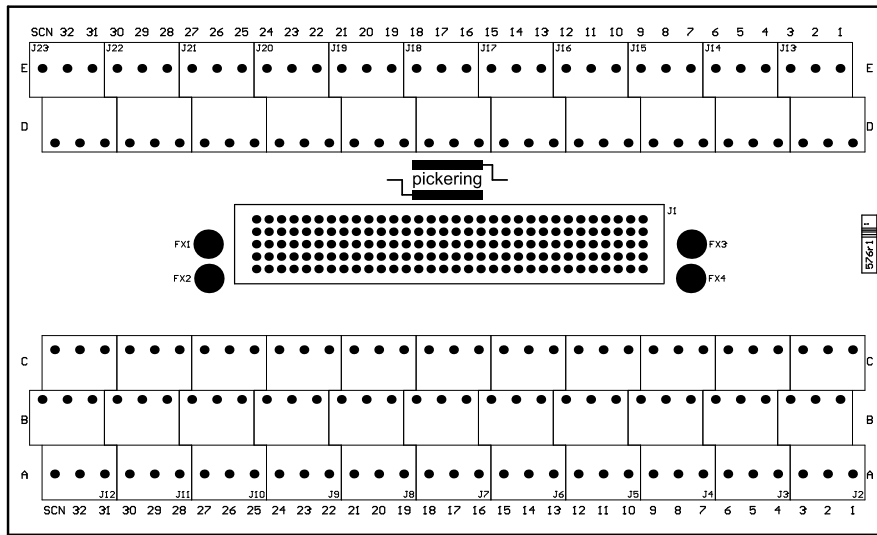

PCB Layout

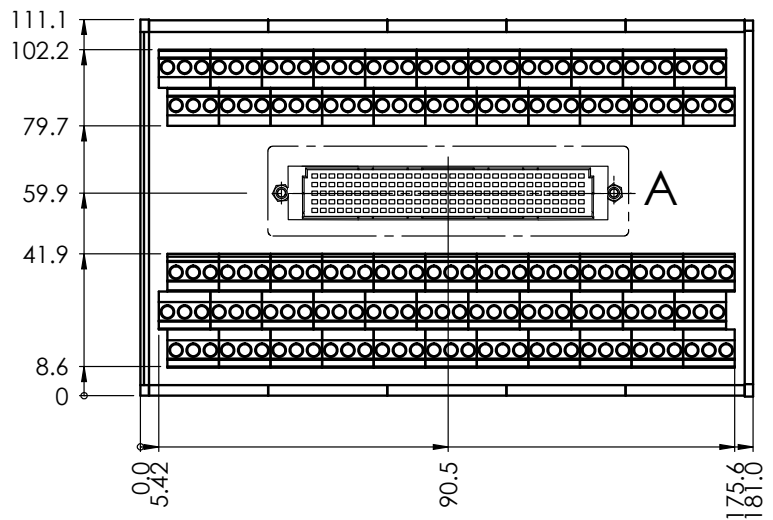
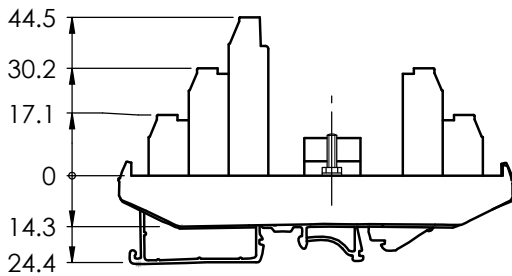

Breakout Dimensions (40-967-160-F)

- Connector only or Connector and Backshell
- Crimp-Pins for Easy Cable Termination
- Cable Clamp in Backshell
- An Alternative PXI Front Panel 44-960-160-FP is Available for PXI Products Requiring a Second Fixing
- Optional Screwlock Assembly 40-969-101 provides a Second LXI Fixing where Necessary - See Diagram

Suitable for users to create their own cable assemblies, it can be supplied with or without a backshell. Recommended for use with PFA coated 3 Amp cable.

When the product is used without a backshell users should make their own cable strain relief arrangements and ensure appropriate electrical safety precautions are observed.

Technical Specification

Connector Type:	160-Pin DIN41612
Gender	Female
Securing Method:	
Product with Backshell	1 x M2.5 screwlock, male, with side clip (Centrally positioned)
Product without Backshell	Screwlocks not supplied
Wire Connection	Crimp pin
Cable Screen Connection	Solder ring terminal
Connector Ratings:	
Maximum Current	2 A each pin
Maximum Voltage	500 V DC or AC peak
Cable Exit:	Rear
Cable Exit Size	12.1 x 28.2 mm
Overall Size (Approx)	H99 x W18 x D60 mm
160-Pin DIN41612:	
Contact Material	Gold plated copper alloy
Contact Resistance	20 mOhm
Wire Connection:	
Maximum Wire Size	20AWG
Recommended Insulation	PFA
Additional Cable Clamp	Yes (in backshell)

Note: A dimensional drawing can be found on the following page.



160-Pin DIN41612 Female Connector Crimp Pin.
(A Pack of 80 Pins is Available for Use as Spares)



160-Pin DIN41612 Connector



Crimp Tool



Extractor Tool

Note: Tools are available as separate order items.

Product Compatibility

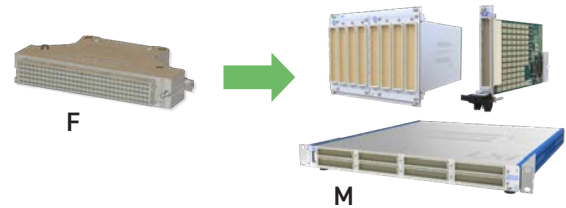

Securing an Individual LXI Connector or other (Non-Screwlock end)

Optional PXI Front Panel 44-960-160-FP

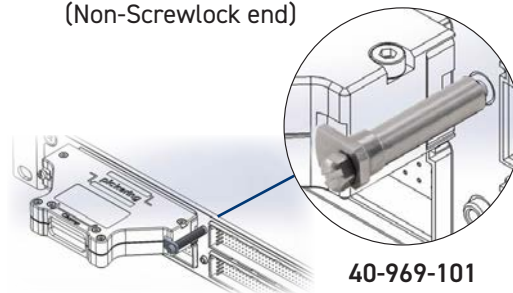

40-969-101

Product Order Codes

160-Pin DIN41612 Connector, Rear Cable Exit, 2 A, Crimp Pin, With Backshell, Female	40-960A-160-F
Without Backshell, Female	92-960-160-F
Crimp Tool, DIN41612	40-964-160-C
Extractor Tool, DIN41612	40-964-160-E
160-Pin DIN41612 Crimp Pin Pack of 80 Female Contacts	40-960A-160-FCP
Screwlock Assy 160-Pin, 4.5 mm AF	40-969-101
3U PXI Front Panel Kit	44-960-160-FP

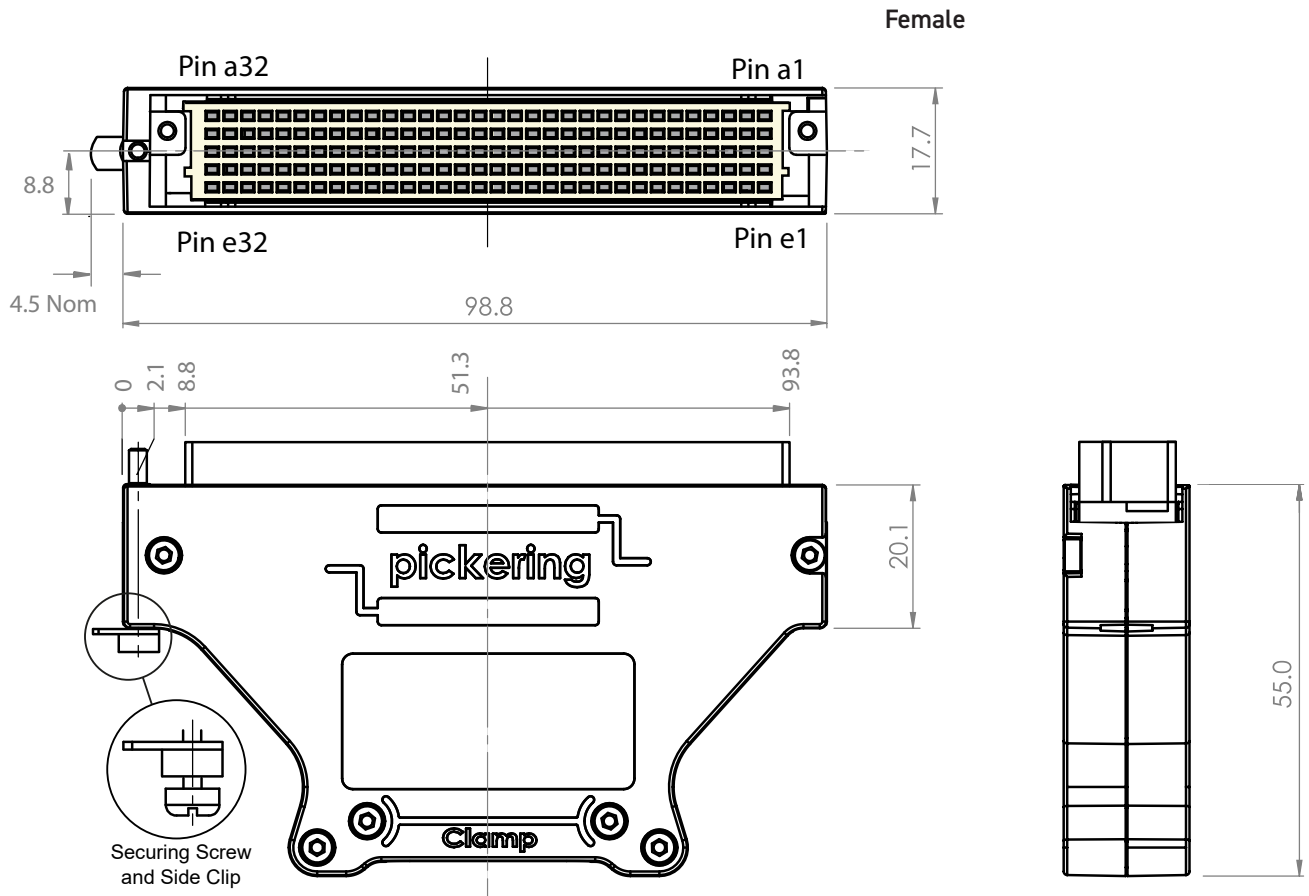

Note: The Side Clip above can be used to secure an adjacent connector

Connector Dimensions (40-960A-160-F)

- 45 Degree Cable Exit
- Crimp-Pins for Easy Cable Termination
- Cable Clamp in Backshell
- An Alternative PXI Front Panel 44-960-160-FP is Available for PXI Products Requiring a Second Fixing
- Optional Screwlock Assembly 40-969-101 provides a Second LXI Fixing where Necessary - See Diagram

Suitable for users to create their own cable assemblies where a 45 degree cable exit would be preferred. Recommended for use with PFA coated 3 Amp cable.

If the user requires LXI connectors to have a second fixing then the connector can be fitted with the optional screwlock assembly 40-969-101 as shown where applications permit.

For PXI products requiring a second fixing, order the PXI Front Panel Kit. The PXI handle is removed on fitting.

Technical Specification

Connector Type:	160-Pin DIN41612
Gender	Female
Securing Method:	1 x M2.5 screwlock, male, with side clip (Centrally positioned)
Wire Connection	Crimp pin
Cable Screen Connection	Solder ring terminal
Connector Ratings:	
Maximum Current	2 A each pin
Maximum Voltage	500 V DC or AC peak
Cable Exit:	45° (Towards Pins a1-e1)
Cable Exit Size	388 mm ² with clamp
Overall Size (Approx)	H99 x W18 x D87 mm
160-Pin DIN41612:	
Contact Material	Gold plated copper alloy
Contact Resistance	20 mOhm
Wire Connection:	
Maximum Wire Size	20AWG
Recommended Insulation	PFA
Additional Cable Clamp	Yes (in backshell)

Note: A dimensional drawing can be found on the following page.

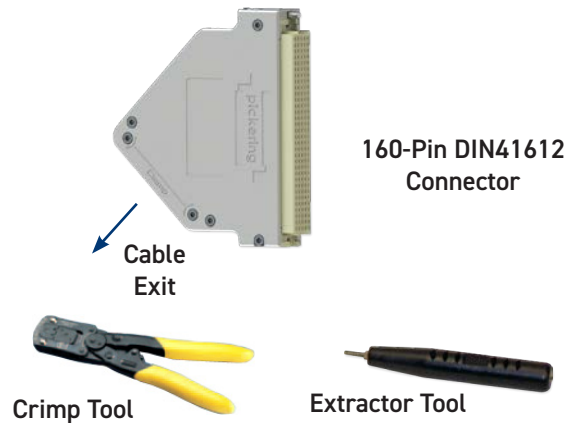

Note: Tools are available as separate order items.

Product Compatibility

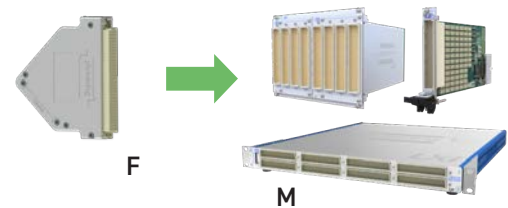

Securing the Non-Screwlock End of the Connector using **40-969-101**

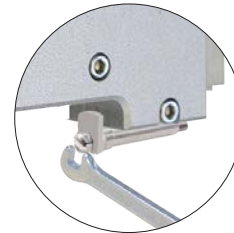

Screwdriver or 4.5 mm AF Spanner Required (Not Supplied)



Product Order Codes

160-Pin DIN41612 Connector, Cable Exit 45° (Towards Pins a1-e1), 2 A, Crimp Pin, With Backshell, Female	40-960-160-F5
Crimp Tool, DIN41612	40-964-160-C
Extractor Tool, DIN41612	40-964-160-E
Screwlock Assy 160-Pin, 4.5 mm AF	40-969-101
3U PXI Front Panel Kit	44-960-160-FP

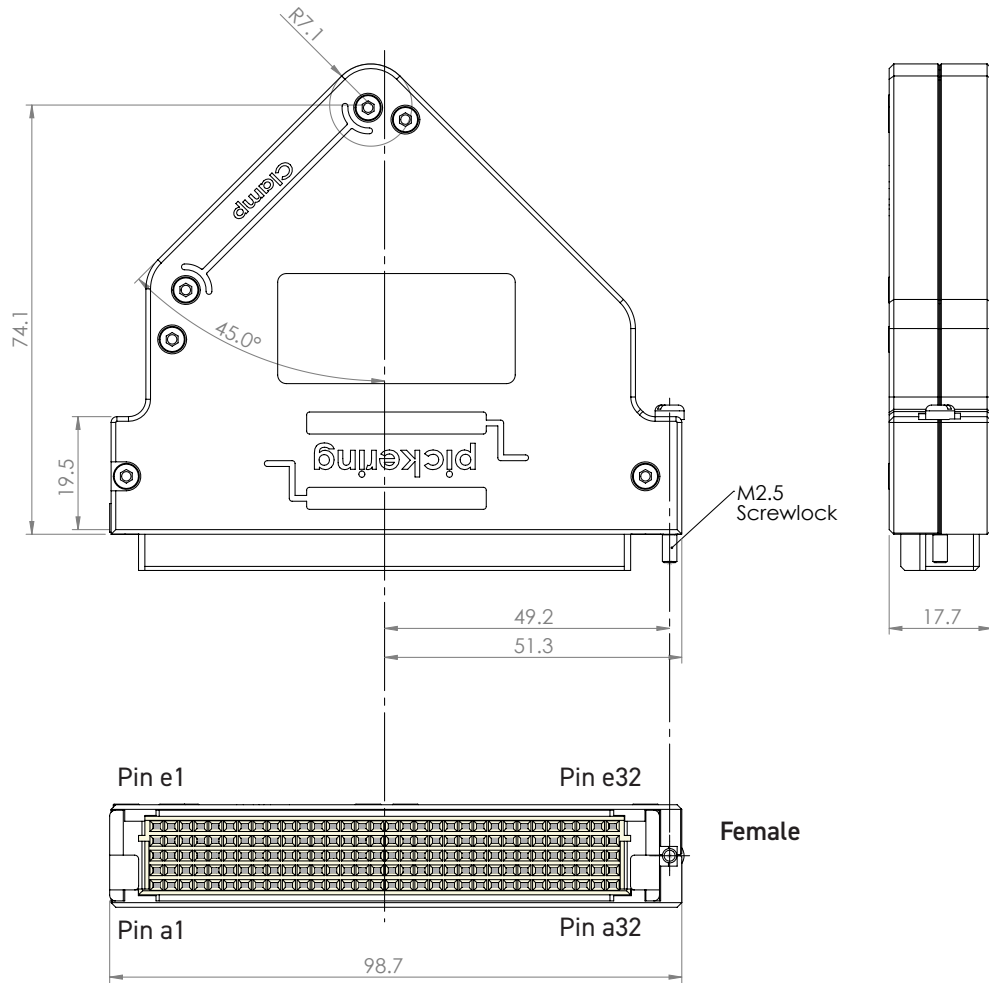

Connector Dimensions (40-960-160-F5)

- 90 Degree Cable Exit
- Crimp-Pins for Easy Cable Termination
- Cable Clamp in Backshell
- An Alternative PXI Front Panel 44-960-160-FP is Available for PXI Products Requiring a Second Fixing
- Optional Screwlock Assembly 40-969-101 provides a Second LXI Fixing where Necessary - See Diagram

Suitable for users to create their own cable assemblies where a 90 degree cable exit would be preferred. Recommended for use with PFA coated 3 Amp cable.

If the user requires LXI connectors to have a second fixing then the connector can be fitted with the optional screwlock assembly 40-969-101 as shown where applications permit.

For PXI products requiring a second fixing, order the PXI Front Panel Kit. The PXI handle is removed on fitting.

Technical Specification

Connector Type:	160-Pin DIN41612
Gender	Female
Securing Method:	1 x M2.5 screwlock, male, with side clip (Centrally positioned)
Wire Connection	Crimp pin
Cable Screen Connection	Solder ring terminal
Connector Ratings:	
Maximum Current	2 A each pin
Maximum Voltage	500 V DC or AC peak
Cable Exit:	90° (Towards Pins a1-e1)
Cable Exit Size	12 x 28 mm
Overall Size (Approx)	H99 x W18 x D67 mm
160-Pin DIN41612:	
Contact Material	Gold plated copper alloy
Contact Resistance	20 mOhm
Wire Connection:	
Maximum Wire Size	20AWG
Recommended Insulation	PFA
Additional Cable Clamp	Yes (in backshell)

Note: A dimensional drawing can be found on the following page.

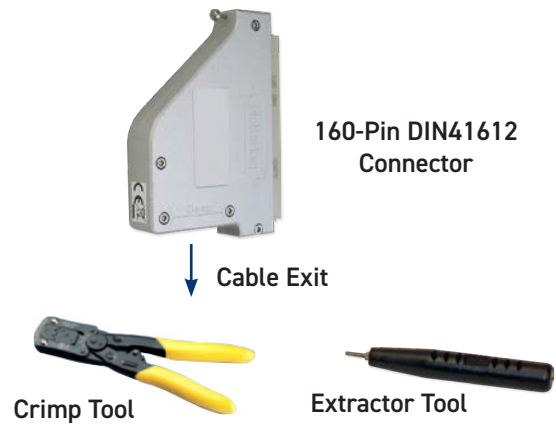

Note: Tools are available as separate order items.

Product Compatibility

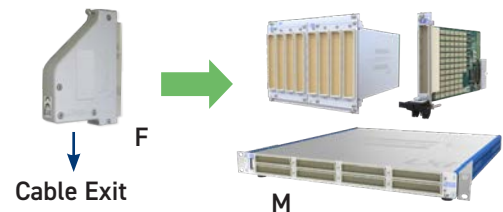

Securing the Non-Screwlock End of the Connector using 40-969-101

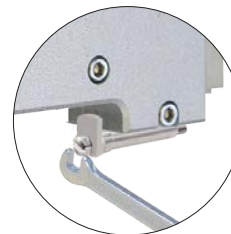

Screwdriver or 4.5 mm AF Spanner Required (Not Supplied)



Optional PXI Front Panel 44-960-160-FP

Product Order Codes

160-Pin DIN41612 Connector, Cable Exit 90° (Towards Pins a1-e1), 2 A, Crimp Pin, With Backshell, Female	40-960-160-FT
Crimp Tool, DIN41612	40-964-160-C
Extractor Tool, DIN41612	40-964-160-E
Screwlock Assy 160-Pin, 4.5 mm AF	40-969-101
3U PXI Front Panel Kit	44-960-160-FP

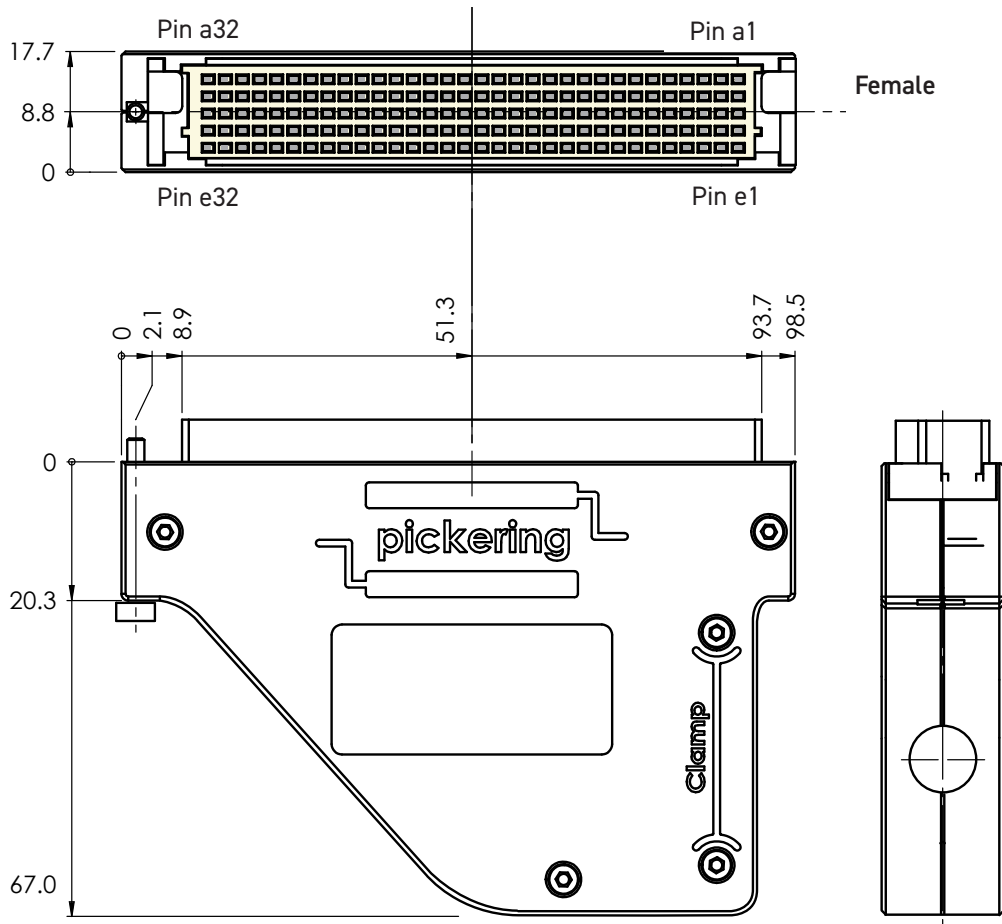

Connector Dimensions (40-960-160-FT)

- Mates with a Pickering Cable Assembly
- Right Angle PCB Mount
- Ideal for User Created Termination Solutions

This accessory allows a user to create their own PCB based termination solution mounted on the end of a cable. Suitable cables for this product are contained elsewhere in this data sheet. Interfacing PCBs should be designed with suitable clearances for the voltage the application requires.

Note: This product is not suitable for directly mounting onto the front panel of a Pickering switching product.

Technical Specification

Connector Type:	160-Pin DIN41612
Gender	Female
Securing Method	Push fit
PCB Mounting	Right angle PCB mount, solder
Connector Ratings:	
Maximum Current	2 A each pin
Maximum Voltage	500 V DC or AC peak
160-Pin DIN41612:	
Contact Material	Gold plated copper alloy
Contact Resistance	<20 mOhm
PCB Legs:	
Effective Leg Length	3 mm nom (See diagram)

Note: Dimensional drawings can be found on the following page.



160-Pin DIN41612 PCB Connector

Product Compatibility

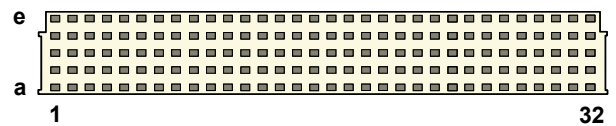
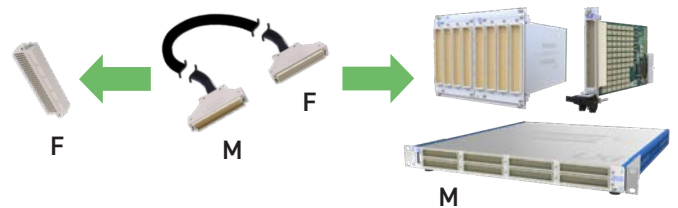

Mating Face of the Female PCB Connector

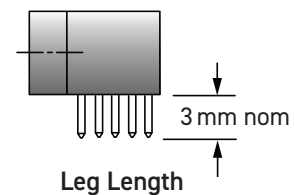

Product Order Codes

160-Pin DIN41612 Connector, 2 A, Right Angle PCB Mount, Female [40-963-160-RF](#)

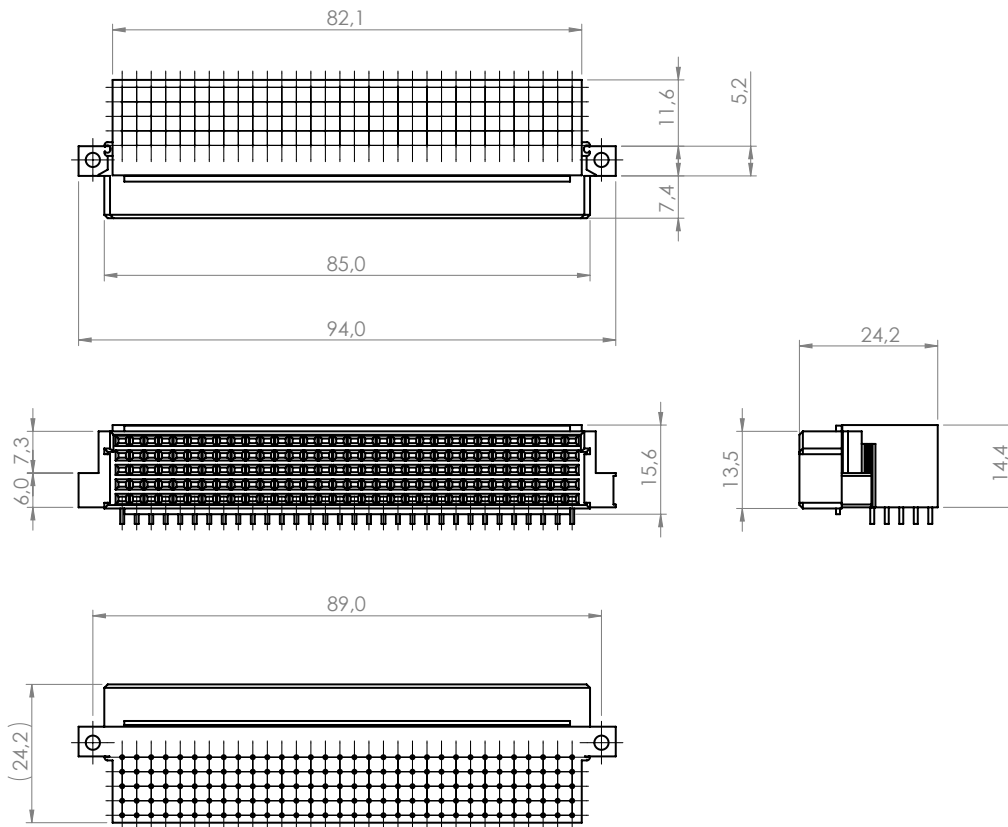

Connector Dimensions (40-963-160-RF)
3rd Angle Dimensioned Drawing (mm)

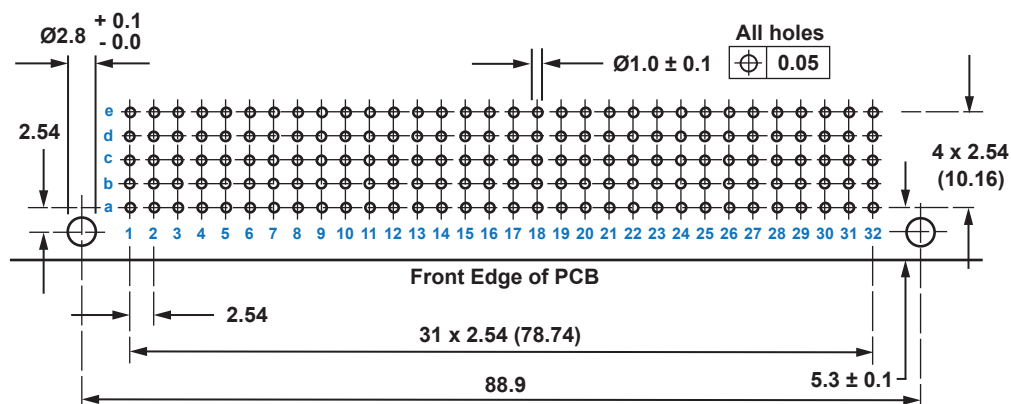

Important: If you have a manufacturer's data sheet the pin numbers 1 to 32 are reversed.

PCB Footprint of 160-Pin Right Angle Female Connector
(Connector Side - Not to Scale) Dimensions as IEC 60-603-2

- Mates with a Pickering Cable Assembly
- Straight PCB Mount
- Ideal for User Created Termination Solutions

Pickering cable assemblies for this product are contained elsewhere in this data sheet. Interfacing PCBs should be designed with suitable clearances for the voltage that the application requires.

Note: This product is not suitable for directly mounting onto the front panel of a Pickering switching product.

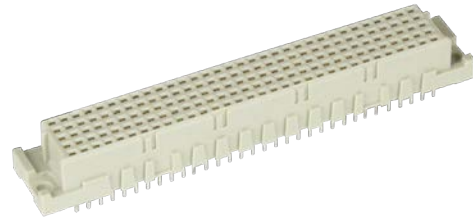

160-Pin DIN41612 PCB Connector

Technical Specification

Connector Type:	160-Pin DIN41612
Gender	Female
Securing Method	Push fit/M2.5 screwlocks, male
PCB Mounting	Straight PCB mount, solder
Connector Ratings:	
Maximum Current	2 A each pin
Maximum Voltage	500 V DC or AC peak
160-Pin DIN41612:	
Contact Material	Gold plated copper alloy
Contact Resistance	<20 mOhm
PCB Legs:	
Leg Length	4 mm nom (See diagram)

Product Compatibility

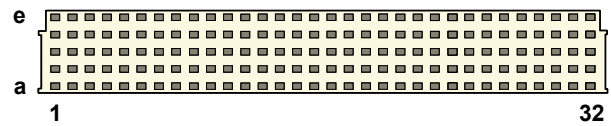
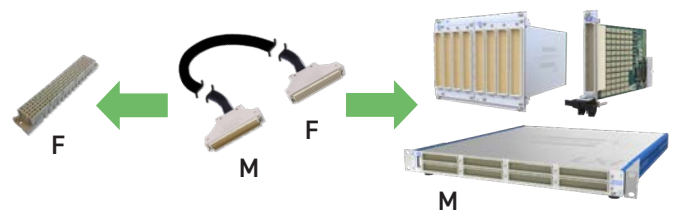

Mating Face of the Female PCB Connector

Note: Dimensional drawings can be found on the following page.

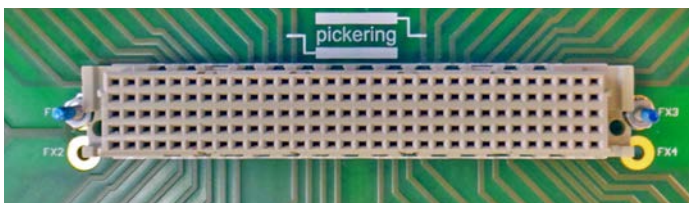

Detail showing Screwlock positions for the Straight Connector C1604FX-4PS-0A

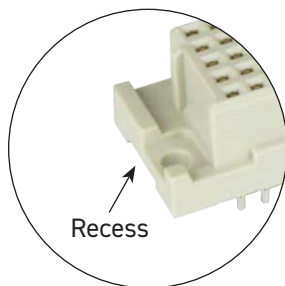
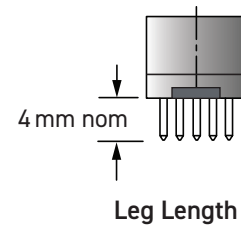

Detail showing the Connector recess for a Screwlock
This recess is provided at both ends of the connector

Product Order Codes

160-Pin DIN41612 Connector, 2 A, Straight PCB Mount, Female **C1604FX-4PS-0A**

Note: PCB Screwlock fixings are included in the kit.

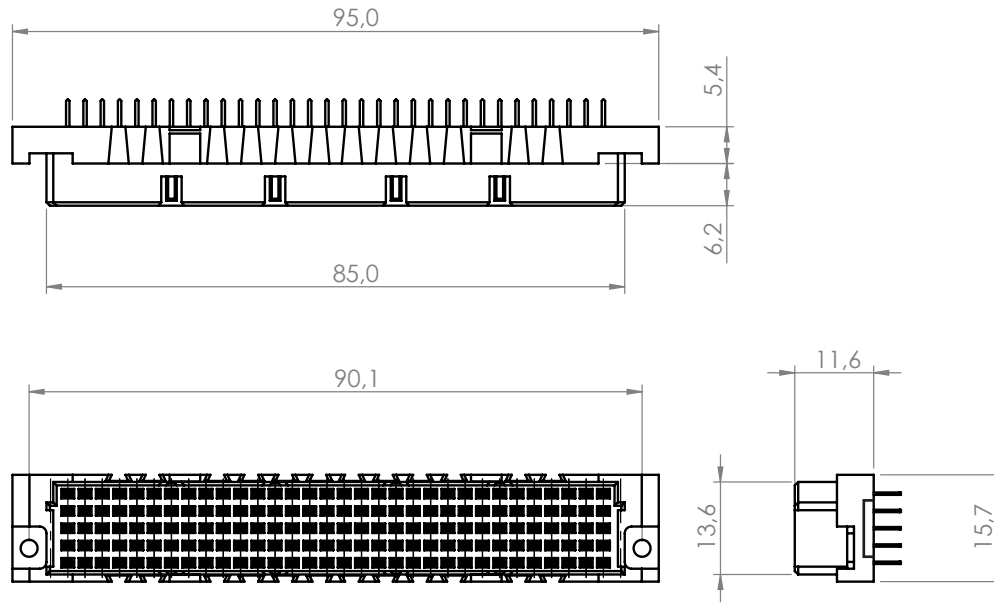

Connector Dimensions (C1604FX-4PS-0A)
3rd Angle Dimensioned Drawing (mm)

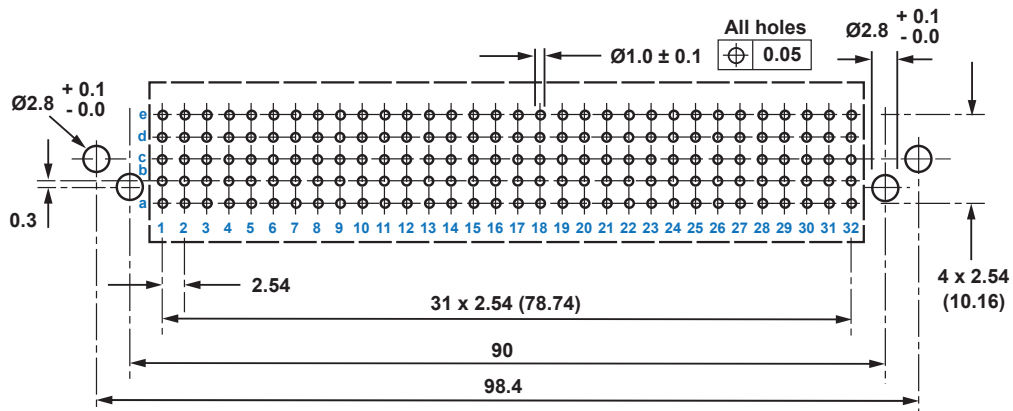

PCB Footprint of 160-Pin Straight Female Connector
(Connector Side - Not to Scale) Dimensions as IEC 60-603-2

- For Connection at Cable End
- Simple to Use Rising Cage Screw Clamp Termination
- DIN Rail Mounted

Connector blocks provide a convenient method of termination without the use of custom cabling. However, a higher resistance path, lower capacity ratings and lower voltage ratings are typical.

This termination option is capable of accepting heavy duty connection wires and uses rising clamp screw terminals to minimize the danger of copper strand damage. Users should care take to protect the termination and provide a suitable method of restraining the cables.

When using this product please ensure appropriate electrical safety precautions are observed.

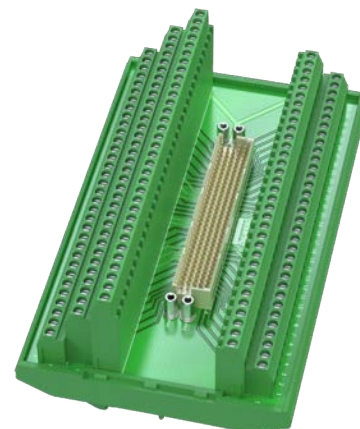

160-Pin DIN41612 Breakout

Technical Specification

Connector Type:	160-Pin DIN41612
Gender	Male
Securing Method:	2 x M2.5 screwlocks, female (Centrally positioned and offset)
Wire Connection	Rising cage screw terminals A screen connection is provided
Breakout Ratings:	
Maximum Current	2 A
Maximum Voltage	500 V DC or AC peak
Securing Method	Suitable for securing to DIN rails.
Overall Size (Approx)	H181 x W112 x D69 mm
160-Pin DIN41612:	
Contact Material	Gold plated copper alloy
Contact Resistance	<20 mOhm
Screw Terminals:	
Maximum Wire Size	12AWG
Additional Cable Clamp	No

Note: Dimensional drawings can be found on the following page.

Product Compatibility

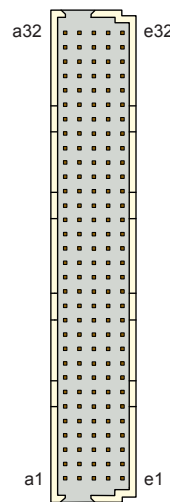
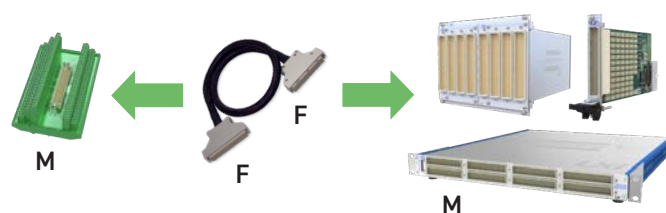

Male Mating Face

Securing a Connector
(Non-Screwlock end)



40-969-101

Product Order Codes

160-Pin Din41612 Breakout with DIN Rail Mount, 2 A, Screw Terminal, Male	40-967-160-M
Screwlock Assy 160-Pin, 4.5 mm AF	40-969-101

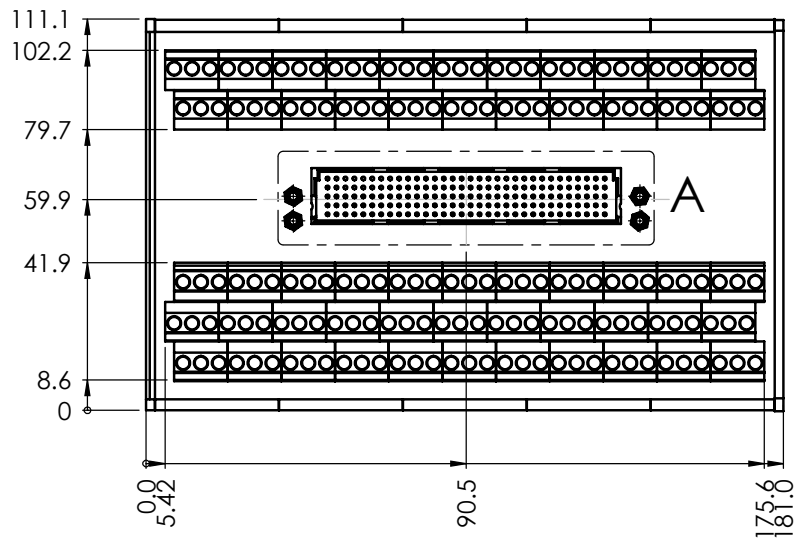
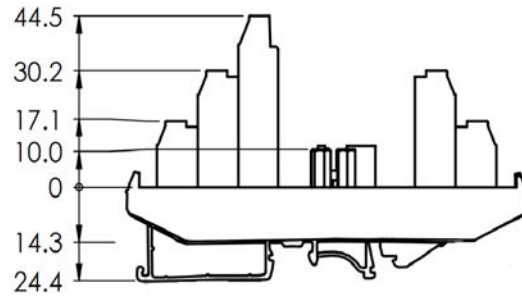

Breakout Dimensions (40-967-160-M)

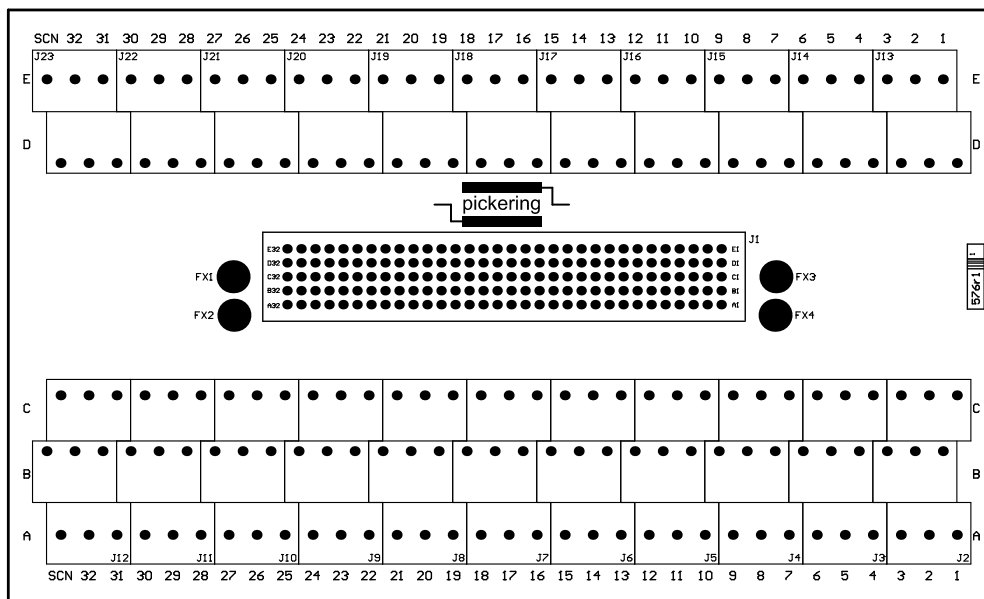

PCB Layout including Connector and Pillar Positions

- Mates with a Pickering Cable Assembly
- Right Angle PCB Mount
- Ideal for User Created Termination Solutions

This accessory allows a user to create their own PCB based termination solution mounted on the end of a cable. Suitable cables for this product are contained elsewhere in this data sheet. Interfacing PCBs should be designed with suitable clearances for the voltage the application requires.

Note: This product is not suitable for directly mounting onto the front panel of a Pickering switching product.

Technical Specification

Connector Type:	160-Pin DIN41612
Gender	Male
Securing Method	Push fit
PCB Mounting	Right angle PCB mount, solder
Connector Ratings:	
Maximum Current	2 A each pin
Maximum Voltage	500 V DC or AC peak
160-Pin DIN41612:	
Contact Material	Gold plated copper alloy
Contact Resistance	<20 mOhm
PCB Legs:	
Effective Leg Length	3 mm nom (See diagram)

Note: Dimensional drawings can be found on the following page.

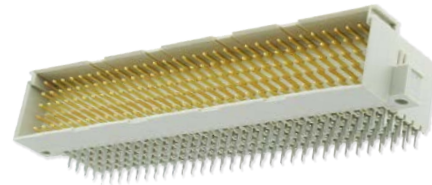

160-Pin DIN41612 PCB Connector

Product Compatibility

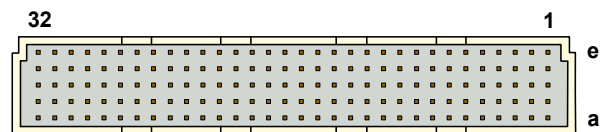
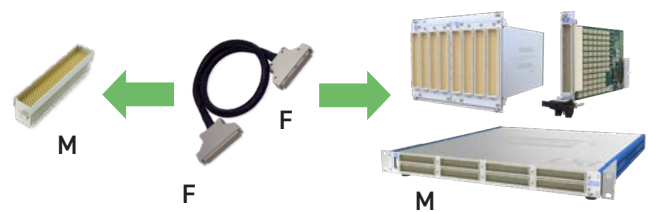

Mating Face of Male PCB Connector

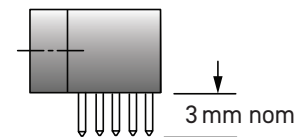

Effective Leg Length

Product Order Codes

160-Pin DIN41612 Connector, 2 A, Right Angle PCB Mount, Male 40-963-160-RM

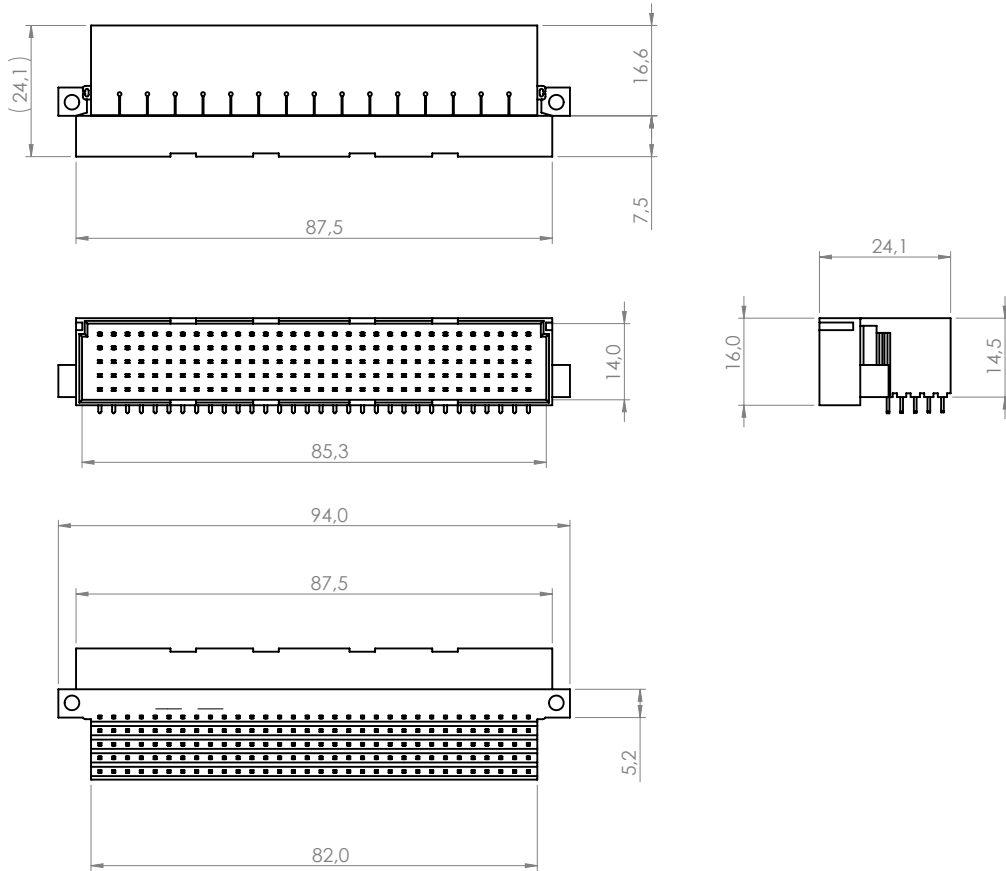

Connector Dimensions (40-963-160-RM)
3rd Angle Dimensioned Drawing (mm)

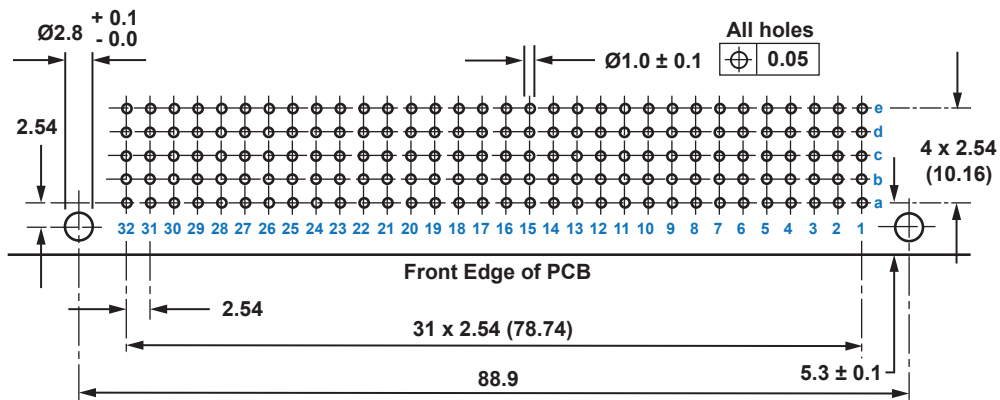

PCB Footprint of 160-Pin Right Angle Connector
(Connector Side - Not to Scale) Dimensions as IEC 60 603-2

- Mates with a Pickering Cable Assembly
- Straight PCB Mount
- Ideal for User Created Termination Solutions

Pickering cable assemblies for this product are contained elsewhere in this data sheet. Interfacing PCBs should be designed with suitable clearances for the voltage that the application requires.

Note: This product is not suitable for directly mounting onto the front panel of a Pickering switching product.

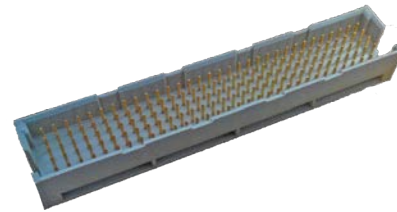

160-Pin DIN41612 PCB Connector

Technical Specification

Connector Type:	160-Pin DIN41612
Gender	Male
Securing Method	Push fit/M2.5 screwlocks, female
PCB Mounting	Straight PCB mount, solder
Connector Ratings:	
Maximum Current	2 A each pin
Maximum Voltage	500 V DC or AC peak
160-Pin DIN41612:	
Contact Material	Gold plated copper alloy
Contact Resistance	<20 mOhm
PCB Legs:	
Leg Length	4 mm nom (See diagram)

Note: Dimensional drawings can be found on the following page.

Product Compatibility

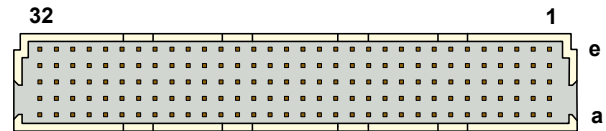
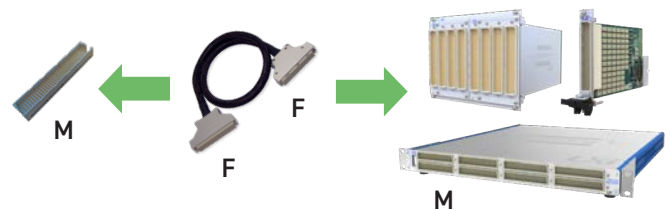

Mating Face of Male PCB Connector

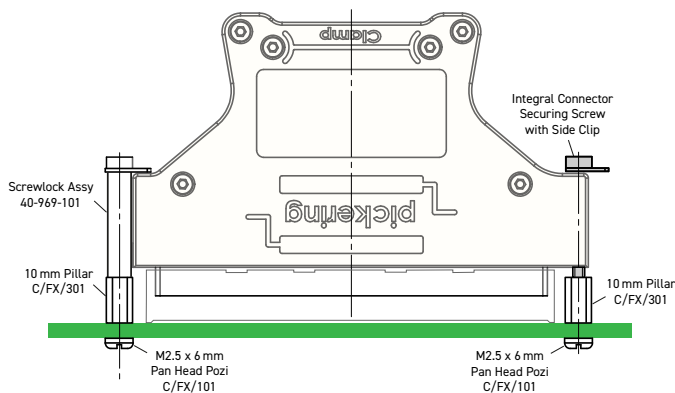
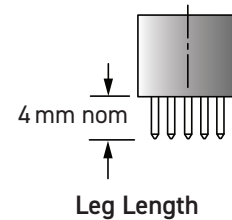

Additional Fixings that May be Required to Secure a Mating Connector

Product Order Codes

160-Pin DIN41612 Connector, 2 A, Straight PCB Mount, Male [40-963-160-SM](#)

Screwlock Assembly Kit [40-969-102](#)

Kit contents: 2 x Screwlock Assy 40-969-101,
2 x 10 mm Brass Pillars,
2 x M2.5 x 6 mm Pan Head Pozi Screws.

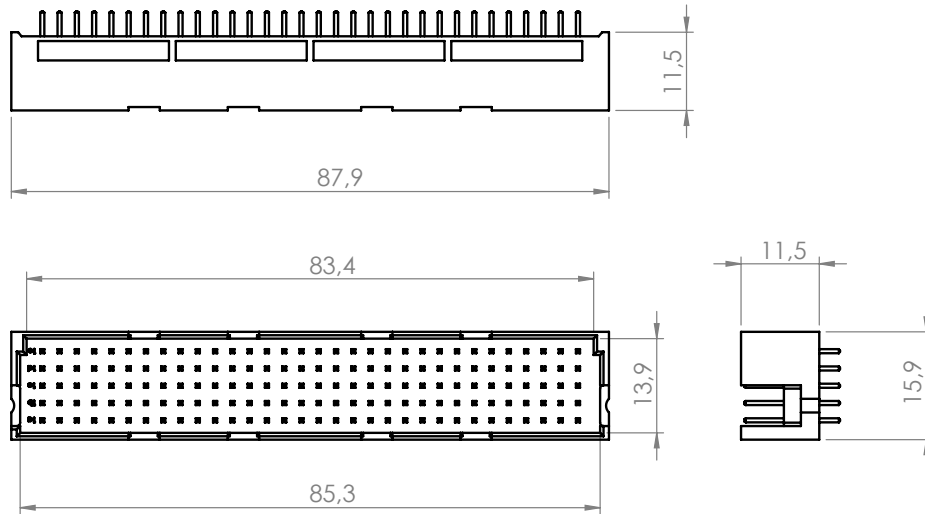

Connector Dimensions (40-963-160-SM)
3rd Angle Dimensioned Drawing (mm)

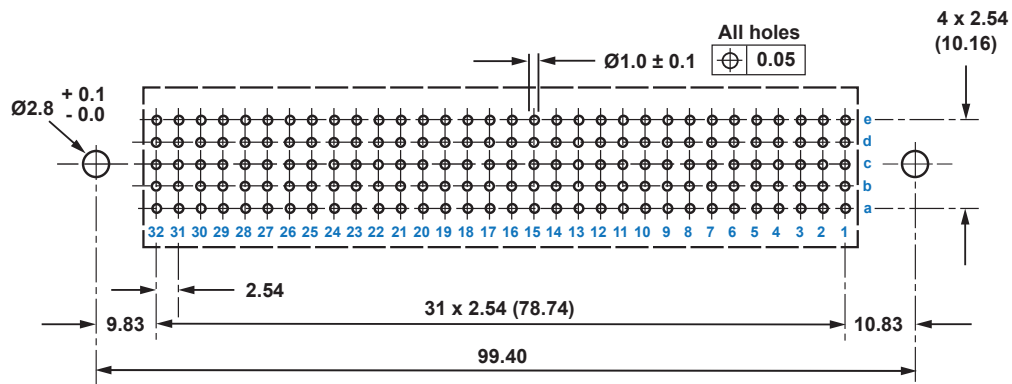

Important: If you have a manufacturer's data sheet the pin numbers 1 to 32 are reversed.

PCB Footprint of 160-Pin Straight Connector
(Connector Side - Not to Scale) Dimensions as IEC 60 603-2

Additional Connection Accessories

Although these items do not directly mate with Pickering Interfaces products customers may find them useful in the development of their own connection solutions.

- High Specification, Highly Flexible Cable
- Fully Screened Cable Construction with Strain Relief
- Rear Cable Exit

Technical Specification

Connector Type (End A):	160-Pin DIN41612
Gender	Male
Securing Method	2 x M2.5 screwlocks, female (centrally positioned)
Connector Type (End B):	160-Pin DIN41612
Gender	Male
Securing Method	2 x M2.5 screwlocks, female (centrally positioned)
Maximum Current	2 A
Maximum Voltage	500 V DC or AC peak
Insulation Resistance	1000 MOhm
Connectors:	
Contact Material	Gold plated copper alloy
Contact Resistance	<20 mOhm
Cable Exit	Rear
Overall Size (Approx)	H99 x W18 x D61mm
Cable Type:	Individual wires, screened & sleeved
Conductor: Material	Silver plated copper wire
Strands	7/0.15 (0.124 mm ² , 26AWG)
Resistance	0.137 Ω/m
Insulation	PFA
Outer Sleeve	Polyester
Screened Construction	Yes (Cable screen connected to backshells)
Additional Braided Sleeve	Yes
Cable O/D	15 mm
Minimum Bend Radius	25 mm
Door Closure Allowance	105 mm (see diagram)

This Cable Assembly is Not Suitable for Connection to a Pickering Switching Product

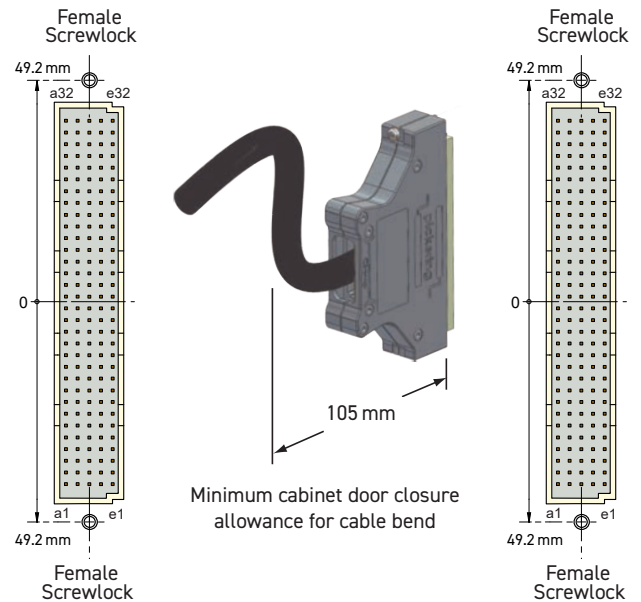
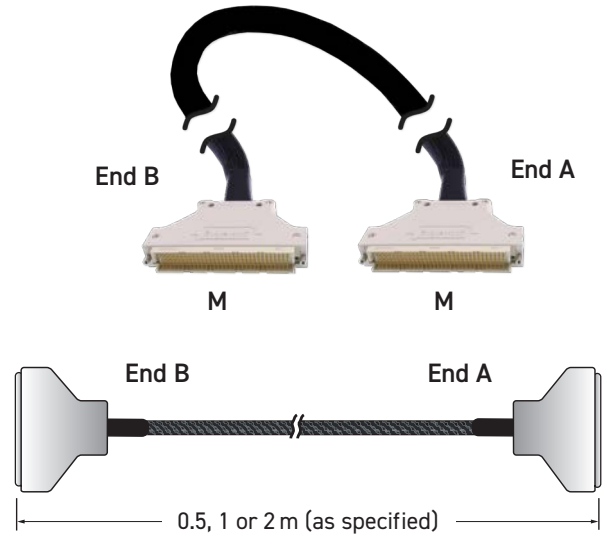

End A - Male Mating Face

End A - Male Mating Face

Characteristic Plots for 40-970-160-0.5m

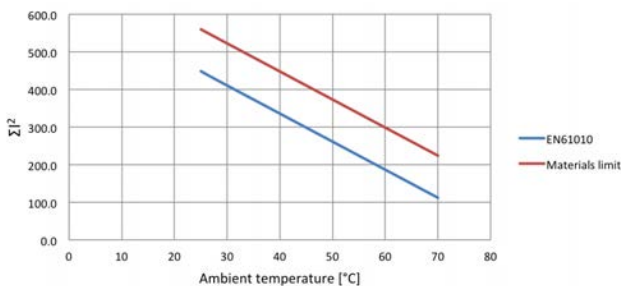

The graph shows the permitted ΣI^2 versus ambient temperature in accordance with EN61010 for user exposure to surface temperature and a higher limit imposed by the materials used where the cable is not directly user accessible.

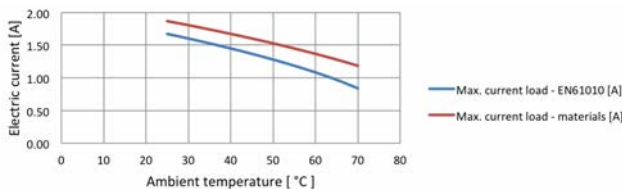

The graph shows the allowed current versus temperature assuming ALL wires carry the same current. Higher currents to the cable rating are permitted on individual wires provided the ΣI^2 is complied with.

Product Order Codes

- 160-Pin DIN41612 Cable Assy, 2 A, Male to Male,
- 0.5 m Long [40-970-160-0.5m-MM](#)
 - 1.0 m Long [40-970-160-1m-MM](#)
 - 2.0 m Long [40-970-160-2m-MM](#)

Note: Other cable lengths can be supplied.

- High Specification, Highly Flexible Cable
- Fully Screened Cable Construction with Strain Relief
- Fully Coded Markers to Ensure Easy Connection

Technical Specification

Connector Type (End A):	160-Pin DIN41612
Gender:	Male
Securing Method:	2 x M2.5 screwlocks, female (centrally positioned)
Unterminated End (End B):	
Wire End Options:	Ferrules, Tinned, Cut End
Free Wire Length:	130 mm nominal
Individual Wire Labelling:	To connector pins A white/black screen pigtail is also included
Maximum Current:	2 A
Maximum Voltage:	500 V DC or AC peak
Insulation Resistance:	1000 MOhm
Connector:	
Contact Material:	Gold plated copper alloy
Contact Resistance:	<20 mOhm
Cable Exit:	Rear
Overall Size (Approx):	H99 x W18 x D61 mm
Cable Type:	Individual wires, screened & sleeved
Conductor: Material:	Silver plated copper wire
Strands:	7/0.15 (0.124 mm ² , 26AWG)
Resistance:	0.137 Ω/m
Insulation:	PFA
Outer Sleeve:	Polyester
Screened Construction:	Yes (Cable screen connected to backshell)
Additional Braided Sleeve:	Yes
Cable O/D:	15 mm
Minimum Bend Radius:	25 mm
Door Closure Allowance:	105 mm (see diagram)

This Cable Assembly is Not Suitable for Connection to a Pickering Switching Product

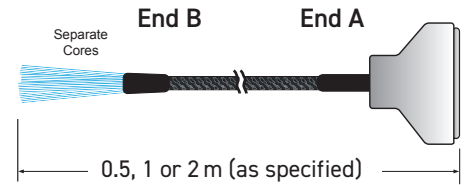

End B Options

Ferrules
Dia as Sleeve
7 mm Nom

Soldered or Crimped Construction

Tinned End
Dia as Tinned Wire
6 mm Nom

Cut End
Simple Cut

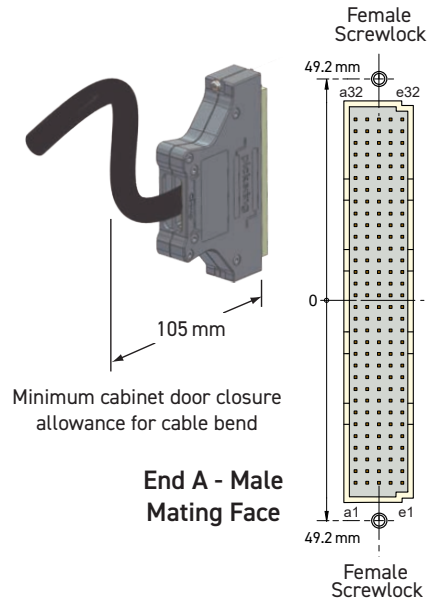

Characteristic Plots for 40-972-160-0.5m

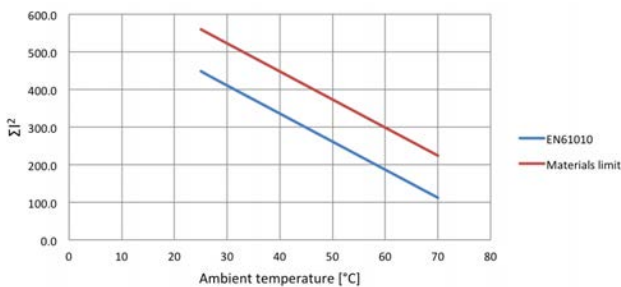

The graph shows the permitted ΣI^2 versus ambient temperature in accordance with EN61010 for user exposure to surface temperature and a higher limit imposed by the materials used where the cable is not directly user accessible.

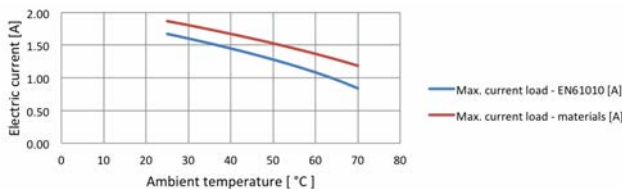

The graph shows the allowed current versus temperature assuming ALL wires carry the same current. Higher currents to the cable rating are permitted on individual wires provided the ΣI^2 is complied with.

Note: When using this product please ensure appropriate electrical safety.

Product Order Codes

- 160-Pin DIN41612 Cable Assy, 2 A, Boot Lace Ferrules, Male to Unterminated, 0.5 m Long [40-972-160-0.5m-MU](#)
- Male to Unterminated, 1.0 m Long [40-972-160-1m-MU](#)
- Male to Unterminated, 2.0 m Long [40-972-160-2m-MU](#)

Part numbers for Cut End and Tinned End options:

A1604MR-*-0A***

End B: T = Tinned End C = Cut End	Cable Length: 050 = 0.5 m 100 = 1.0 m 200 = 2.0 m
--	---

Note: Other cable lengths can be supplied.

- Connector and PCB Only or Connector, PCB and Backshell
- Female Screwlocks
- Cable Clamp in Backshell
- Easy to Use Rising Cage Screw Terminals

Connector blocks provide a convenient method of termination without the use of custom cabling. However, a higher resistance path, lower capacity ratings and lower voltage ratings are typical.

This connector block provides a simple method of connecting to high density DIN41612 connectors. The screw terminals use a rising cage clamp mechanism to minimize risk of copper strand breakage. PTFE/PFA cables are recommended for use with this connector block to maximise copper cross-sectional area and insulation properties. Connector blocks will have higher losses than a cable connection and the breakdown voltage is controlled by clearances to the metal shell. The metal shell includes an internal insulation barrier under the carrier board.

Technical Specification

Connector Type:	160-Pin DIN41612
Gender	Male
Securing Method:	
Product with Backshell	1 x M2.5 screwlock, female (centrally positioned)
Product without Backshell	Screwlocks not supplied
Wire Connection	Rising cage screw terminals
Cable Screen Connection	Solder ring terminal
Connector Block Ratings:	
Maximum Current	2 A
Maximum Voltage	200 V DC or AC peak
Cable Exit	Dual rear - 11 x 24 mm
Overall Size (Approx)	H99 x W19 x D143 mm
160-Pin DIN41612:	
Contact Material	Gold plated copper alloy
Contact Resistance	<20 mOhm
Screw Terminals:	
Maximum Wire Size	16AWG
Recommended Insulation	PTFE/PFA
Additional Cable Clamp	Yes (in backshell)

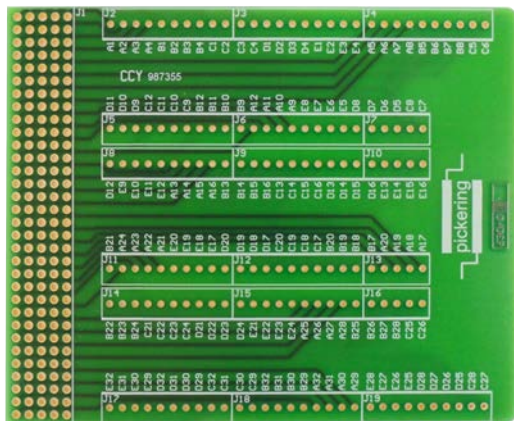

PCB Legend

This Connector Block is Not Suitable for Connection to a Pickering Switching Product

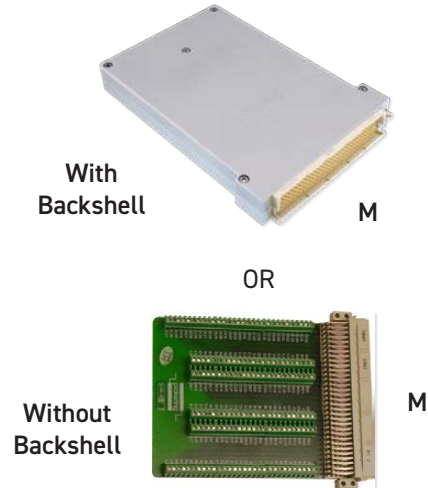

Product Compatibility

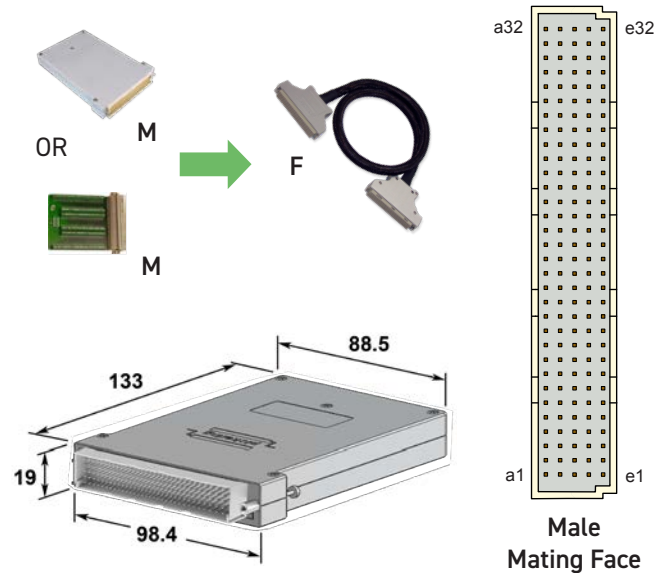

Connector Block Dimensions

Note: When the product is used without a backshell appropriate safety precautions should be observed.

Product Order Codes

160-Pin DIN41612 Connector Block, 2 A, Screw Terminal, With Backshell, Female	B1604MR-4F-0A
Without Backshell, Female	92-965-160-M

- Male Version with 2 off M2.5 Screwlocks
- Connector only or Connector and Backshell
- Cable Clamp in Backshell

Suitable for users to create their own cable assemblies, the connector can be supplied with or without a backshell. Recommended for use with PFA coated 3 Amp cable.

When the product is used without a backshell users should make their own cable strain relief arrangements and ensure appropriate electrical safety precautions are observed.

This Connector is Not Suitable for Connection to a Pickering Switching Product

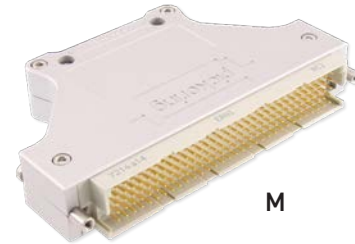

With Backshell

Technical Specification

Connector Type:	160-Pin DIN41612
Gender	Male
Securing Method:	
Product with Backshell	2 x M2.5 screwlocks, female (Centrally positioned)
Product without Backshell	Screwlocks not supplied
Wire Connection	Solder pin
Cable Screen Connection	Solder ring terminal
Connector Ratings:	
Maximum Current	2 A each pin
Maximum Voltage	500 V DC or AC peak
Cable Exit:	Rear
Cable Exit Size	322 mm ²
Overall Size (Approx)	H102.5 x W17.7 x D61.3 mm
160-Pin DIN41612:	
Contact Material	Gold plated copper alloy
Contact Resistance	<20 mOhm
Wire Connection:	
Maximum Wire Size	26AWG
Recommended Insulation	PFA
Additional Cable Clamp	Yes (in backshell)

Connector Dimensions

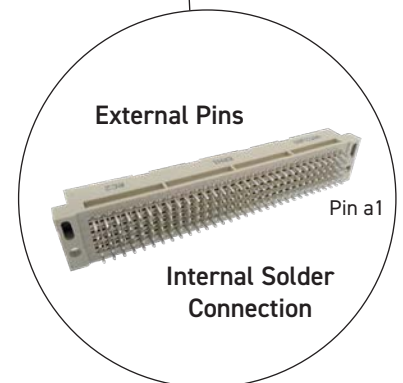
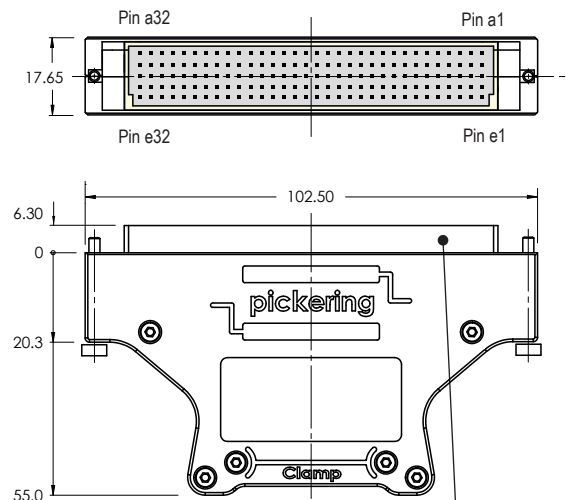

Product Order Codes

160-Pin DIN41612 Connector, Rear Cable Exit, 2 A, Solder Pin, With Backshell, Male	40-960-160-M
Without Backshell, Male	92-960-160-M

- Straight PCB Mount Connector
- Ideal for User Created Termination Solutions

Interfacing PCBs should be designed with suitable clearances for the voltage that the application requires.

Note: This product is not suitable for directly mounting onto the front panel of a Pickering switching product.

Technical Specification

Connector Type:	160-Pin DIN41612
Gender	Female
Securing Method	Push fit
PCB Mounting	Straight PCB mount, solder
Connector Ratings:	
Maximum Current	2 A each pin
Maximum Voltage	500 V DC or AC peak
160-Pin DIN41612:	
Contact Material	Gold plated copper alloy
Contact Resistance	<20 mOhm
PCB Legs:	
Leg Length	4 mm nom (See diagram)

Note: Dimensional drawings can be found on the following page.

This Connector is Not Suitable for Connection to a Pickering Switching Product

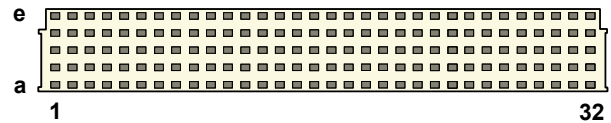
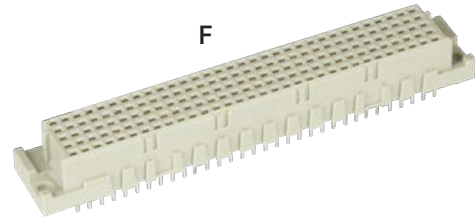

Mating Face of Female PCB Connector

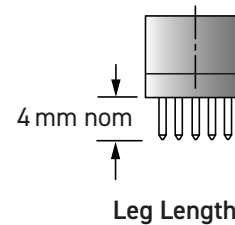

Product Order Codes

160-Pin DIN41612 Connector, 2 A, Straight PCB Mount, Female [40-963-160-SF](#)

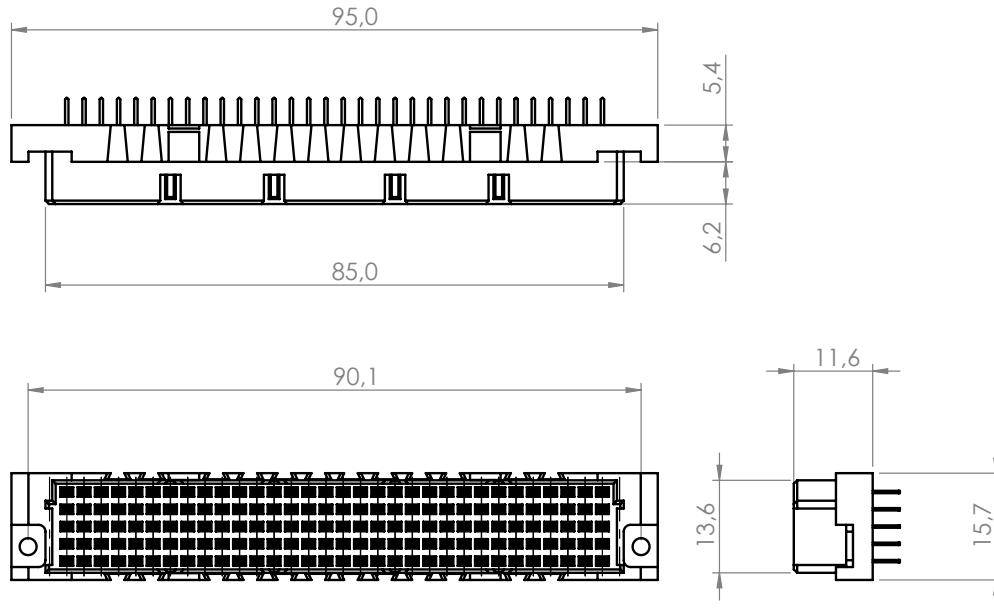

Connector Dimensions (40-963-160-SF)
3rd Angle Dimensioned Drawing (mm)

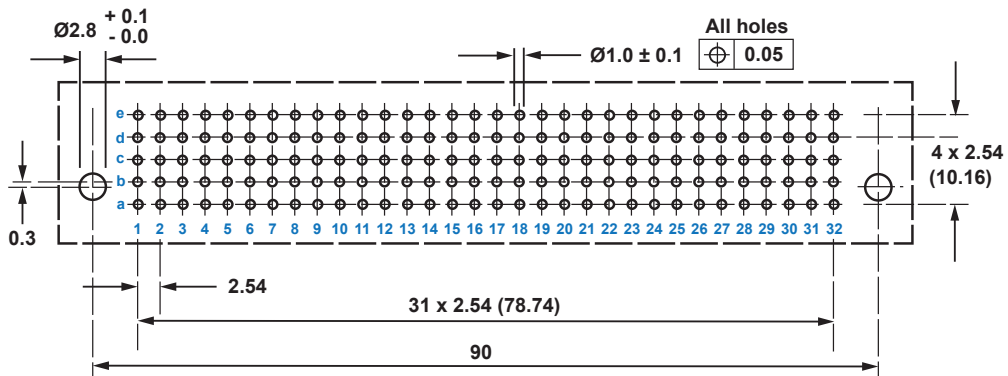

PCB Footprint of 160-Pin Straight Female Connector
(Connector Side - Not to Scale) Dimensions as IEC 60 603-2

- Straight PCB Mount Connector
- Ideal for User Created Termination Solutions

Interfacing PCBs should be designed with suitable clearances for the voltage that the application requires.

Note: This product is not suitable for directly mounting onto the front panel of a Pickering switching product.

This Connector is Not Suitable for Connection to a Pickering Switching Product

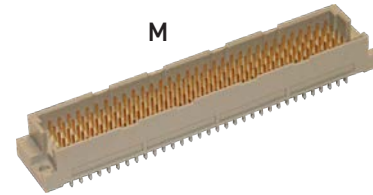

Technical Specification

Connector Type:	160-Pin DIN41612
Gender	Male
Securing Method	Push fit
PCB Mounting	Straight PCB mount, solder
Connector Ratings:	
Maximum Current	2 A each pin
Maximum Voltage	500 V DC or AC peak
160-Pin DIN41612:	
Contact Material	Gold plated copper alloy
Contact Resistance	<20 mOhm
PCB Legs:	
Leg Length	4 mm nom (See diagram)

Note: Dimensional drawings can be found on the following page.

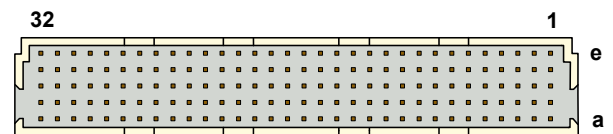

Mating Face of Male PCB Connector

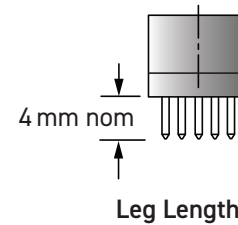

Product Order Codes

160-Pin DIN41612 Connector, 2 A, Straight PCB Mount, Male [C1604MX-XPS-0A](#)

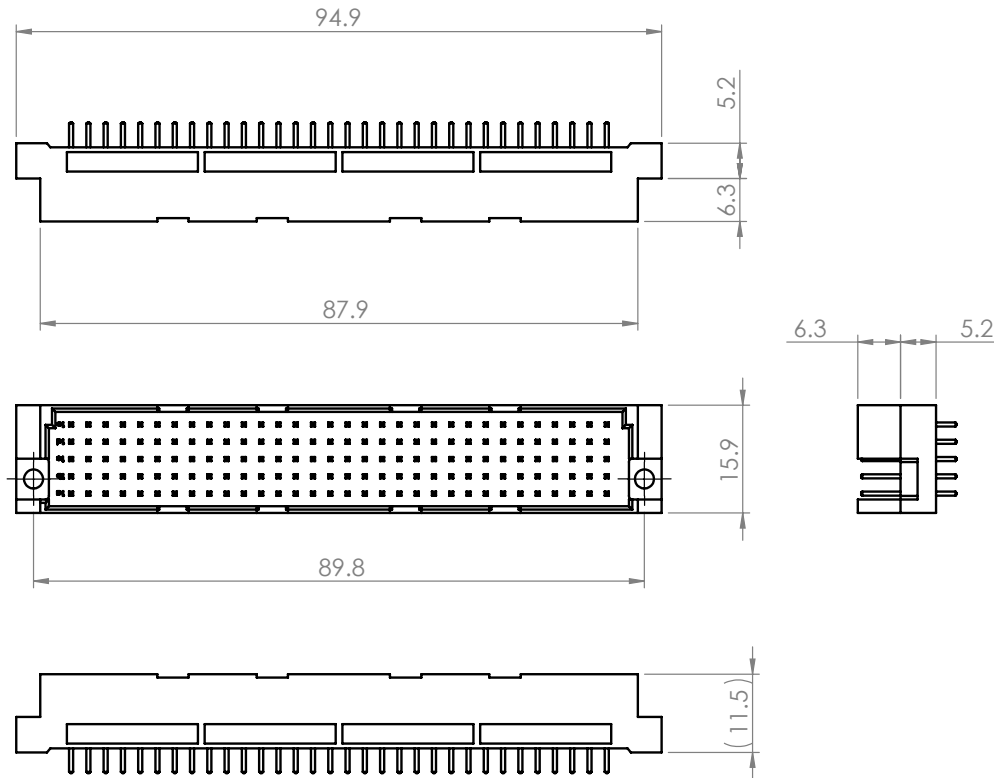

Connector Dimensions (C1604MX-XPS-0A)
3rd Angle Dimensioned Drawing (mm)

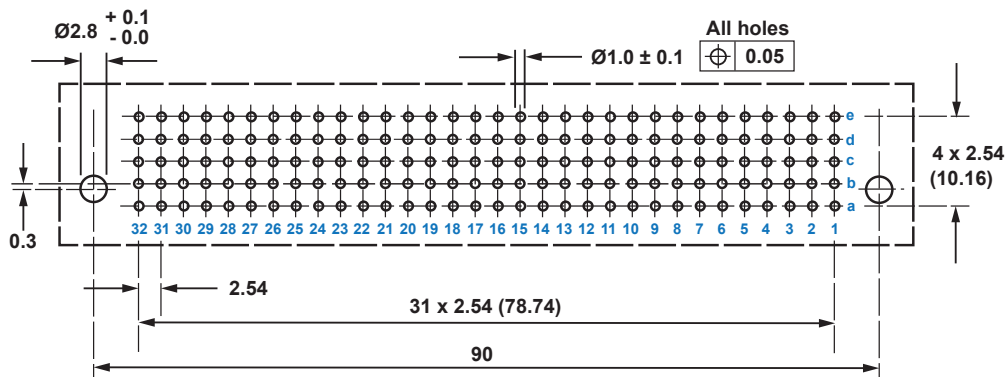

Important: If you have a manufacturer's data sheet the pin numbers 1 to 32 are reversed.

PCB Footprint of 160-Pin Straight Male Connector
(Connector Side - Not to Scale) Dimensions as IEC 60-603-2



Appendix

This appendix gives details of recent part number changes.

ECN1832 Dated 27th March 2023

This Change Note covered a change to the female connector backshell with a rear exit. The backshell has been changed from machined aluminium to diecast zinc alloy with nickel plating. The shape and overall dimensions are very similar.

Items that changed and the corresponding updated part numbers are detailed below:

Product changes in data sheet order		Data Sheet 90-001D Issue 10.7 May 2023	Data Sheet 90-001D Issue 10.8 June 2023
		Product Part Numbers	Product Part Numbers
	Cable Assy, 160-Pin DIN41612, 2 A Female to Female	40-970-160-*m-FF	40-970A-160-*m-FF
	Cable Assy, 160-Pin DIN41612, 2 A Female to Unterminated	40-972-160-*m-FU A1604FR-T-OA*** A1604FR-C-OA***	40-972A-160-*m-FU A1604FR-T-OB*** A1604FR-C-OB***
	Cable Connector 160-Pin DIN41612, 2 A, Crimp-Pin, Female	40-960-160-F	40-960A-160-F

Custom Termination

Pickering Interfaces are able to manufacture custom built cable assemblies and backshells that mate with all the connectors we use in our extensive product range and to provide connection solutions for third party products.

We are able to model and manufacture cable assemblies and other termination arrangements to user notes and drawings, and to deal with simple and complex assemblies, and both small and high volume orders.

All products are designed to ensure easy and problem free connection.

We offer a fast turn round of custom items to keep your ordering and integration time scales to a minimum.



Pickering's Cable Design Tool

Our Cable Design Tool is an online tool that allows you to define a cable assembly to exactly meet your requirements.

- Graphical design of customized cable assemblies
- Built-in library of standard cable sets can be used as the basis for customization, or cables can be defined from scratch
- The ability to store cable assemblies in the Cloud and develop them over time
- Each cable design has a PDF documentation file detailing all the specifications
- Allows detailed design including; connector types, wire type, pin definitions, pin & cable labelling, cable bundling, length selection, sleeving, comments, etc.
- Add your own connectors and wires
- Fully supported on major tablet operating systems

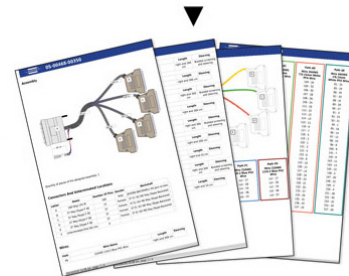
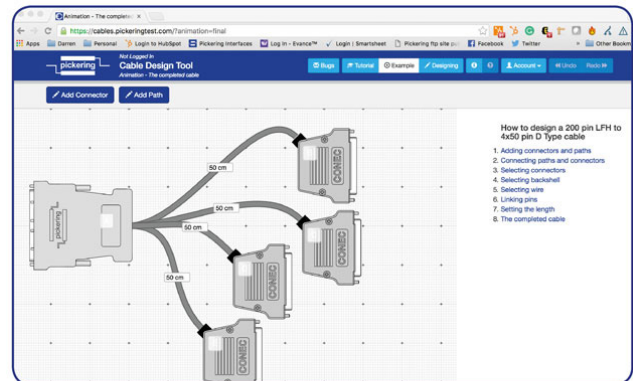

Because the Cable Design Tool is a web-based tool, we will continually update it to better accommodate your requirements and features. Your data is not trapped; complete details of the design are always available to the user at any time via the documentation or spreadsheet file. Once a cable is designed, you can submit it to us for quotation.

For more information visit: pickeringtest.com/cdt